

**Lectures on  
Wave Propagation**

**By  
G.B. Whitham**

**Tata Institute of Fundamental Research  
Bombay  
1979**

**Lectures on  
Wave Propagation**

**By  
G. B. Whitham**

Published for the  
**Tata Institute of Fundamental Research, Bombay**

**Springer-Verlag**

Berlin Heidelberg New York

**1979**

## **Author**

**G.B. Whitham, F.R.S.**

Applied Mathematics 101-50  
Firestone Laboratory  
California Institute of Technology  
Pasadena, California 91125, U.S.A.

© **Tata Institute of Fundamental Research, 1979**

---

ISBN 3-540-08945-4 Springer-Verlag Berlin. Heidelberg. New York  
ISBN 0-387-08945-4 Springer-Verlag New York. Heidelberg. Berlin

---

No part of this book may be reproduced in any form by print, microfilm or any other means without written permission from the Tata Institute of Fundamental Research, Colaba, Bombay 400 005

Printed by M. N. Palwankar at the TATA PRESS Limited,  
414, Veer Savarkar Marg, Bombay 400 025 and published by  
H. Goetze, Springer-Verlag, Heidelberg, West Germany

Printed In India



# Preface

THESE ARE THE lecture notes of a course of about twentyfour lectures given at the T.I.F.R. centre, Indian Institute of Science, Bangalore, in January and February 1978.

The first three chapters provide basic background on the theory of characteristics and shock waves. These are meant to be introductory and are abbreviated versions of topics in my book “Linear and nonlinear waves”, which can be consulted for amplification.

The main content is an entirely new presentation. It is on water waves, with special emphasis on old and new results for waves on a sloping beach. This topic was chosen as a versatile one where an enormous number of the methods and techniques used in applied mathematics could be illustrated on a single area of application. In the relatively short time available, I wanted to avoid spending time on the formulation of problems in different areas. Waves on beaches together with ramifications to islands, tsunamis, etc., is also a very active field of research.

In any current course on wave propagation, it seemed essential to mention, at least, the quite amazing results being found on exact, solutions for the Korteweg-de Vries equation and related equations. Since this has now become such a huge subject, the choice was to present a new approach we have developed (largely by R. Rosales), rather than review the original and alternative approaches. Since the Kortewegde Vries equation and its solutions originated in water wave theory, this fits well with the other material. Like the other topics, the mathematical results go far beyond this original field and have many other applications.

The enthusiasm and participation of the audience made this the most enjoyable teaching experience I have ever had. I wish to thank the students, faculty and N.A.L. participants for their kindness and stimulation.

Notes were taken by G. Vijayasundaram and P.S. Datti, and I thank them for their devoted efforts.

Professors K.G. Ramanathan and K. Balagangadharan gave most generously of their time and energy to make all aspects of our visit smooth and enjoyable. We are sincerely grateful.

**G.B. Whitham**

Pasadena, California

August, 1978

# Contents

<b>Preface</b>	<b>v</b>
<b>1 Introduction to Nonlinear Waves</b>	<b>1</b>
1.1 One dimensional linear equation . . . . .	1
1.2 A basic non-linear wave equation . . . . .	2
1.3 Expansion wave . . . . .	7
1.4 Centred expansion wave . . . . .	10
1.5 Breaking . . . . .	11
<b>2 Examples</b>	<b>15</b>
2.1 Traffic Flow . . . . .	16
2.2 Flood waves in rivers . . . . .	19
2.3 Chemical exchange processes . . . . .	19
2.4 Glaciers . . . . .	20
2.5 Erosion . . . . .	21
<b>3 Shock Waves</b>	<b>23</b>
3.1 Discontinuous shocks . . . . .	24
3.2 Equal area rule . . . . .	26
3.3 Asymptotic behavior . . . . .	28
3.4 Shock structure . . . . .	32
3.5 Burger's equation . . . . .	36
3.6 Chemical exchange processes; Thomas's equation . . . . .	38

<b>4</b>	<b>A Second Order System; Shallow Water Waves</b>	<b>41</b>
4.1	The equations of shallow water theory . . . . .	41
4.2	Simple waves . . . . .	44
4.3	Method of characteristics for a system . . . . .	48
4.4	Riemann's argument for simple waves . . . . .	50
4.5	Hodograph transformation . . . . .	52
<b>5</b>	<b>Waves on a Sloping Beach; Shallow Water Theory</b>	<b>55</b>
5.1	Shallow water equations . . . . .	55
5.2	Linearized equations . . . . .	57
5.3	Linear theory for waves on a sloping beach . . . . .	58
5.4	Nonlinear waves on a sloping beach . . . . .	63
5.5	Bore on beach . . . . .	72
5.6	Edge waves . . . . .	72
5.7	Initial value problem and completeness . . . . .	75
5.8	Weather fronts . . . . .	77
<b>6</b>	<b>Full Theory of Water Waves</b>	<b>79</b>
6.1	Conservation equations and the boundary value problem . . . . .	79
6.2	Linearized theory . . . . .	84
<b>7</b>	<b>Waves on a Sloping Beach: Full Theory</b>	<b>89</b>
7.1	Normal incidence . . . . .	89
7.2	The shallow water approximation . . . . .	101
7.3	Behavior as $\beta \rightarrow 0$ . . . . .	102
7.4	General $\beta$ . . . . .	105
7.5	Oblique incidence and edge waves . . . . .	105
7.6	Oblique incidence, $k < \lambda < \infty$ . . . . .	110
7.7	Edge waves, $0 < \lambda < k$ . . . . .	113
<b>8</b>	<b>Exact Solutions for Certain Nonlinear Equations</b>	<b>117</b>
8.1	Solitary waves . . . . .	118
8.2	Perturbation approaches . . . . .	120
8.3	Burgers' and Thomas's equations . . . . .	120
8.4	Korteweg-de Vries equation . . . . .	127
8.5	Discrete set of $\alpha$ 's interacting solitary waves . . . . .	129



<i>Contents</i>	ix
8.6 Continuous range; Marcenko integral equation . . . . .	131
8.7 The series solution . . . . .	134
8.8 Other equations . . . . .	136
<b>Bibliography</b>	<b>136</b>



# Chapter 1

## Introduction to Nonlinear Waves

### 1.1 One dimensional linear equation

1

The Wave equation

$$\phi_{tt} = c_0^2 \nabla^2 \phi$$

occurs in the classical fields of acoustics, electromagnetism and elasticity and many familiar “mathematical methods” were developed on it.

The solution of the one-dimensional form,

$$(1.1) \quad \phi_{tt} - c_0^2 \phi_{xx} = 0,$$

is almost trivial. Introducing the variables  $\alpha, \beta$  by

$$\alpha = x - c_0 t,$$

$$\beta = x + c_0 t,$$

equation (1.1) becomes  $\phi_{\alpha\beta} = 0$ . The general solution of this equation is

$$\phi = f(\alpha) + g(\beta)$$

Therefore, the general solution of (1.1) is

$$(1.2) \quad \phi(x, t) = f(x - c_0 t) + g(x + c_0 t);$$

$f, g$  are determined by the initial or boundary conditions.

(i) For the initial value problem

$$t = 0 : \phi = \phi_0(x), \phi_t = \phi_1(x) > -\infty < x < \infty,$$

the solution is

$$(1.3) \quad \phi(x, t) = \frac{\phi_0(x - c_0 t) + \phi_0(x + c_0 t)}{2} + \frac{1}{2c_0} \int_{x-c_0 t}^{x+c_0 t} \phi_1(s) ds.$$

2

(ii) For the signalling problem

$$t = 0 : \phi = 0, \phi_t = 0, x > 0,$$

$$x = 0 : \phi = \phi(t), t > 0,$$

the solution in  $x > 0, t > 0$ , is

$$(1.4) \quad \phi = \begin{cases} 0 & , t < \frac{x}{c_0}, \\ \phi\left(t - \frac{x}{c_0}\right) & , t > \frac{x}{c_0}. \end{cases}$$

## 1.2 A basic non-linear wave equation

The solution  $f$  and  $g$  correspond to the two factors when equation (1.1) is written as

$$\left(\frac{\partial}{\partial t} + c_0 \frac{\partial}{\partial x}\right) \left(\frac{\partial}{\partial t} - c_0 \frac{\partial}{\partial x}\right) \phi = 0.$$

While equation (1.1) is simple to handle it would be given simpler if only one of the factors occurred, and we had, for example,

$$\frac{\partial \phi}{\partial t} + c_0 \frac{\partial \phi}{\partial x} = 0,$$

with the solution  $\phi = f(x - c_0 t)$ .

The simplest non-linear wave equation is a counterpart of this, namely:

$$(1.5) \quad \frac{\partial \phi}{\partial t} + c(\phi) \frac{\partial \phi}{\partial x} = 0, t > 0, -\infty < x < \infty,$$

where  $c(\phi)$  is a given function of  $\phi$ . For the initial value problem, we would add the initial condition

$$(1.6) \quad t = 0 : \phi = f(x), -\infty < x < \infty.$$

3

Though this equation looks simple it poses nontrivial problems in the analysis and leads to new phenomena.

The equation can be solved by the method of characteristics. The idea is to note that a linear combination

$$(1.7) \quad a \frac{\partial \phi}{\partial t} + b \frac{\partial \phi}{\partial x}$$

can be interpreted as the directional derivative of  $\phi$  in the direction  $(a, b)$ . A characteristic curve is introduced such that its direction is  $(a, b)$  at each point. Then the equation provides information on the rate of change of  $\phi$  on this curve and we have effectively an ordinary differential equation, which leads to the solution. In applying this idea and carrying out the details for (1.5), we first consider any curve  $\mathcal{C}$  described by  $x = x(t)$ . (See Fig. 1.1)

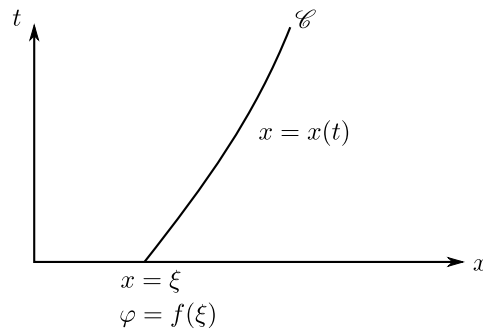

Figure 1.1:

On  $\mathcal{C}$ , we have

$$\phi = \phi(x(t), t);$$

i.e.  $\phi$  may be treated temporarily as a function of  $t$ . Furthermore, on  $\mathcal{C}$  we have

$$(1.8) \quad \frac{d\phi}{dt} = \phi_t + \frac{dx}{dt}\phi_x$$

4

Now to implement the idea noted above we choose  $\mathcal{C}$  so that  $dx/dt = c(\phi)$ . Then the right hand side of (1.8) is just the combination that appears in the equation (1.5) and we have  $d\phi/dt = 0$ . If the initial point on the characteristic curve is denoted by  $\xi$ , then the initial condition (1.6) requires  $\phi(0) = f(\xi)$ . Combining these we have the following “characteristic form”.

$$(1.9) \quad \text{On } \mathcal{C} : \begin{cases} \frac{dx}{dt} = c(\phi), & x(0) = \xi, \\ \frac{d\phi}{dt} = 0, & \phi(0) = f(\xi). \end{cases}$$

We cannot solve (1.9) independently of (1.10) since  $c$  is a function of  $\phi$ . Hence we have a coupled pair of ordinary differential equations on  $\mathcal{C}$ . The solution for  $\phi$  depends on the initial condition; therefore,  $\mathcal{C}$  also depends on the initial condition.

Although (1.9) cannot be solved immediately, (1.10) can. It gives

$$\phi = \text{constant on } \mathcal{C},$$

and therefore

$$\phi = f(\xi) \text{ on the whole of } \mathcal{C}.$$

Then, returning to (1.9) and defining  $F(\xi)$  by

$$F(\xi) = c(f(\xi)),$$

5 we have

$$(1.11) \quad \begin{aligned} \frac{dx}{dt} &= F(\xi), \\ x(0) &= \xi. \end{aligned}$$

Integrating (1.11) we obtain

$$x = tF(\xi) + \xi.$$

The characteristic curve is a straight line whose slope depends on  $\xi$ . Combining the results we have the solution in parametric form

$$(1.12) \quad \phi = f(\xi)$$

$$(1.13) \quad x = \xi + tF(\xi).$$

In making this construction it is easiest to think of just one particular characteristic curve. But from the final answer (1.12)-(1.13), we can then find the solution in a whole  $(x, t)$  region by varying  $\xi$ . This leads to a change of emphasis: To find  $\phi$  at a given  $(x, t)$ , solve (1.13) for  $\xi(x, t)$  and substitute in (1.12). This final form is an analytic statement free of the geometrical construction. We check directly that it solves the problem.

In solving (1.13), there is a unique solution  $\xi(x, t)$  provided

$$(1.14) \quad 1 + tF'(\xi) \neq 0,$$

which we assume for the present.

**Initial condition.** When  $t = 0, \xi = x$  by (1.13). Hence (1.12) implies  $\phi = f(x)$ . 6

**Equation.** Differentiating the equations (1.13) and (1.12) partially w.r.t.  $t$  we obtain

$$\begin{aligned} 0 &= F(\xi) + \{tF'(\xi) + 1\} \xi_t, \\ \phi_t &= f'(\xi) \xi_t. \end{aligned}$$

Eliminating  $\xi_t$  we have

$$\phi_t = -\frac{f'(\xi)F(\xi)}{1 + tF'(\xi)}.$$

Similarly, differentiating the equations (1.13) and (1.12) partially w.r.t.  $x$  and eliminating  $\xi_x$  we find

$$\phi_x = \frac{f'(\xi)}{1 + tF'(\xi)}.$$

Hence

$$\begin{aligned} \phi_t + c(\phi)\phi_x &= -\frac{f'(\xi)F(\xi)}{1 + tF'(\xi)} + F(\xi)\frac{f'(\xi)}{1 + tF'(\xi)} \\ &= 0. \end{aligned}$$

**Uniqueness.** If  $\psi(x, t)$  is some other solution of (1.5) and (1.6) then on  $x = \xi + tF(\xi)$

$$\psi(x, t) = \psi(\xi, 0) = f(\xi) = \phi(x, t).$$

Hence  $\psi \equiv \phi$ .

Thus we have proved the following.

**Theorem.** *The initial value problem*

$$\phi_t + c(\phi)\phi_x = 0, t > 0, -\infty < x < \infty,$$

with  $t = 0 : \phi = f(x), -\infty < x < \infty$ , has a unique solution in

$$0 < t < \frac{1}{\max_{F'(\xi) < 0} |F'(\xi)|}$$

7 if  $f \in C^1(\mathbb{R}), c \in C^1(\mathbb{R})$ , where

$$F(\xi) = c(f(\xi)).$$

The solution is given in the parametric form:

$$x = \xi + tF(\xi),$$

$$\phi(x, t) = f(\xi).$$

**Remark.** When  $c(\phi) = c_0$ , a positive constant, equation (1.5) becomes the linear wave equation:

$$\phi_t + c_0\phi_x = 0.$$

The characteristic curves are  $x = c_0t + \xi$ , and  $\phi$  is given by

$$\phi(x, t) = f(\xi) = f(x - c_0t).$$



### 1.3 Expansion wave

Consider the problem

$$\begin{aligned} \phi_t + c(\phi)\phi_x &= 0, \quad \text{on } t > 0, -\infty < x < \infty, \\ t = 0 : \phi &= f(x), -\infty < x < \infty, \end{aligned}$$

where

$$f(x) = \begin{cases} \phi_2, & \text{if } x \leq 0 \\ \text{monotonic increasing,} & \text{if } 0 \leq x \leq L \\ \phi_1, & \text{if } x \geq L, \end{cases}$$

with  $\phi_1 > \phi_2$  and  $c'(\phi) > 0$ .

We shall let  $c_1 = c(\phi_1)$ ,  $c_2 = c(\phi_2)$ .

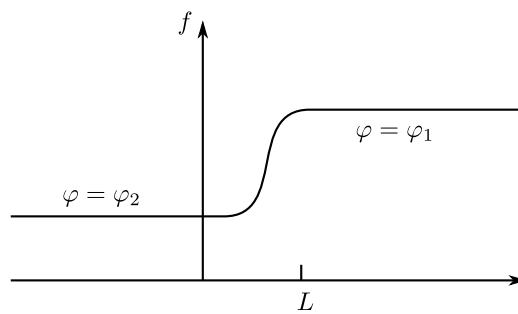

Figure 1.2:

We recall the solution of the problem:

$$\begin{aligned} \phi &= f(\xi), \\ x &= \xi + tF(\xi), \end{aligned}$$

where

$$F(\xi) = c(f(\xi)).$$

Let us consider the characteristics of this problem. For,  $\xi \leq 0$ ,

$$F(\xi) = c(f(\xi)) = c(\phi_2) = c_2.$$

Therefore, the characteristics through  $\xi(\leq 0)$  are straight lines with constant slope  $\frac{1}{c_2}$ .

For  $\xi \geq L$ ,  $F(\xi) = c(f(\xi)) = c(\phi_1) = c_1$ . Hence, the characteristics through  $\xi(\geq L)$  are also straight lines, with constant slope  $\frac{1}{c_1}$ . For  $0 \leq \xi \leq L$ , the characteristics through  $\xi$  are straight lines having slopes  $\frac{1}{F(\xi)}$  with  $\frac{1}{c_1} \leq \frac{1}{F(\xi)} \leq \frac{1}{c_2}$ .

9 Since the characteristics do not intersect, (and this corresponds to (1.14) we obtain  $\phi$  as a single valued function. A typical  $(x, t)$  diagram is shown in Fig. 1.4(b).

The behavior of the solution can be explained geometrically as shown in the figures 1.3(a), 1.3(b).

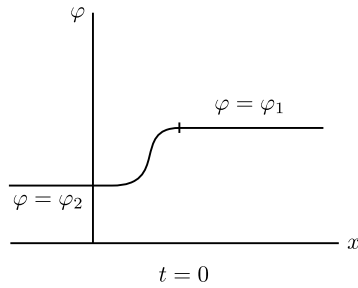

Figure 1.3: (a)

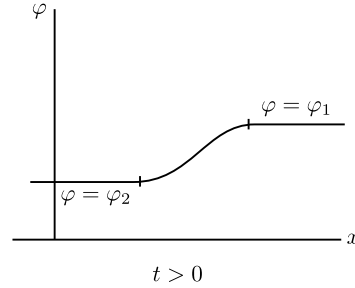

Figure 1.3: (b)

Every point  $(\xi, \phi(\xi))$  at  $t = 0$  will move parallel to the  $x$ -axis through a distance  $c t_1$  in time  $t_1$ . Since  $c'(\phi) > 0$ ,  $\phi_2 < \phi_1$ , the points  $(\xi, \phi_1)$  ( $\xi \geq L$ ) move faster than the points  $(\xi, \phi_2)$  ( $\xi \leq 0$ ). Hence, the graph of  $\phi$  at  $t = 0$  is stretched as the time increases.

The analytic details can be carried out most easily by working entirely with  $c$  as the dependent variable.

### Equation for $C$ :

Consider the equation

$$\phi_t + c(\phi)\phi_x = 0 \quad \text{in } t > 0, -\infty < x < \infty$$

$$t = 0 : \phi = f(x), \quad -\infty < x < \infty.$$

We have found that  $c(\phi)$  is the “propagation speed”, and in constructing solutions we have to deal with two functions, namely,  $\phi$  and  $c$ . But by multiplying the equation by  $c'(\phi)$  we obtain

$$(1.15) \quad \left. \begin{aligned} C_t + CC_x &= 0 && \text{in } t > 0, -\infty < x < \infty, \\ t = 0 : C &= F(x), && -\infty < x < \infty, \end{aligned} \right\}$$

where  $C(x, t) = c(\phi(x, t))$  and

10

$$F(\xi) = c(f(\xi)).$$

This equation involves only the unknown function  $C(x, t) = c(\phi(x, t))$ ; we can recover  $\phi$  from  $C$  afterwards. The solution of the problem in (1.15) is

$$(1.16) \quad \begin{aligned} x &= \xi + tF(\xi), \\ C &= F(\xi), \end{aligned}$$

In the special case,

$$C(x, 0) = \begin{cases} c_2 & \text{in } x \leq 0, \\ c_2 + \frac{c_1 - c_2}{L}x & \text{in } 0 \leq x \leq L, \\ c_1 & \text{in } x \geq L, \end{cases}$$

the  $x - t$  diagram is shown below in Fig. 1.4(b).

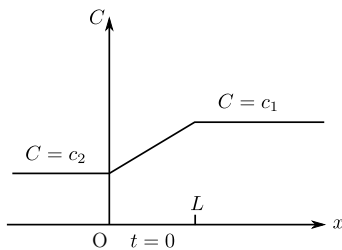

Figure 1.4: (a)

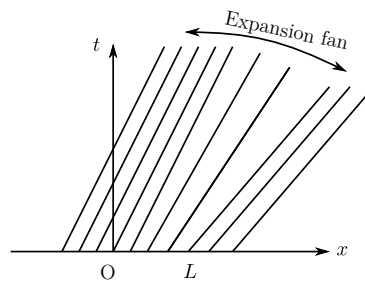

Figure 1.4: (b)

### 1.4 Centred expansion wave

11 We now consider the limiting case of the above problem, as  $L \rightarrow 0$ . In the limit the interval  $[c_2, c_1]$  is associated with the origin. In the limit we will have the characteristics

$$\begin{aligned} x &= \xi + tc_2, & \text{if } \xi < 0, \\ x &= \xi + tc_1, & \text{if } \xi > 0, \\ x &= Ct, & \text{if } \xi = 0, c_2 \leq C \leq c_1. \end{aligned}$$

The collection of characteristics  $x = Ct : C \in [c_2, c_1]$  through the origin is called a 'Centred fan' and we have  $C = x/t$ . In this case the full solution is

$$(1.17) \quad C = \begin{cases} c_2, & \text{if } x \leq c_2t, \\ x/t, & \text{if } c_2t < x < c_1t \\ c_1, & \text{if } x \geq c_1t. \end{cases}$$

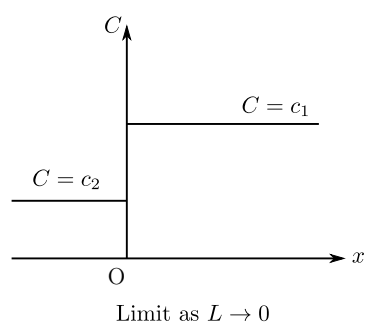

Figure 1.5: (a)

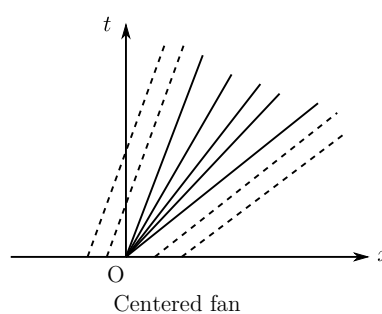

Figure 1.5: (b)

Thus we have the following.

**Theorem.** *The initial value problem*

$$C_t + CC_x = 0, \quad t > 0, \quad -\infty < x < \infty,$$

$$t = 0 : C = \begin{cases} c_2 & \text{if } \xi < 0, \\ c_1 & \text{if } \xi > 0, \end{cases}$$

and  $C$  continuous for  $t > 0$ , has a unique solution given by (1.17).

## 1.5 Breaking

12

We consider again the geometrical interpretation of the solution of the equations (1.5) and (1.6). We assume that  $c'(\phi) > 0$ . The graph of  $\phi$  at time  $t = 0$  is the graph of  $f$ . Since

$$\phi(\xi + tF(\xi), t) = f(\xi),$$

we find that the point  $(\xi, f(\xi))$  moves parallel to  $x$ -axis in the positive direction through a distance  $tF(\xi) = ct$ . It is important to note that the distance moved depends on  $\xi$ ; this is typical of non-linear phenomena. (In the linear case the curve moves parallel to  $x$ -axis with constant velocity  $c_0$ ).

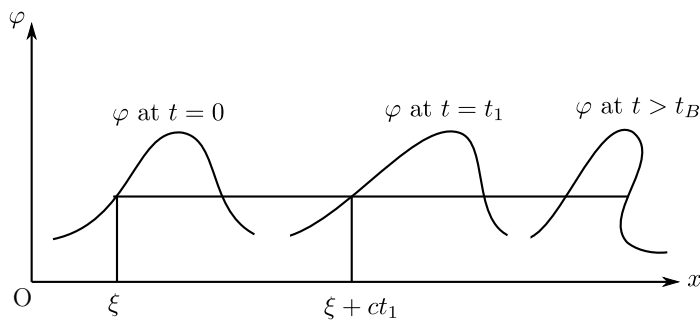

Figure 1.6:

After some time  $t = t_B$ , the graph of the curve  $\phi$  may become many valued as shown in the above figure 1.6. This phenomenon is called “breaking”. It could at least make physical sense in the case of water waves (although the equations are in fact not valid), but in most cases a three valued solution would not make sense. We have to reconsider our approximations and assumptions.

- 13 We have seen that if  $tF'(\xi) + 1 \neq 0$  then breaking will not occur. A necessary and sufficient condition for breaking to occur is that  $F'(\xi) < 0$  for some  $\xi$ . (We assume  $c'(\phi) > 0$ ). For such  $\xi$ 's the envelope of the characteristics is obtained by eliminating  $\xi$  from the equations

$$\begin{aligned}x &= \xi + tF(\xi), \\0 &= tF'(\xi) + 1.\end{aligned}$$

Breaking corresponds to the formation of such an envelope. If we assume that  $F'(\xi)$  is minimum only at  $\xi_B$  and  $F'(\xi_B) < 0$ , the first breaking time will be

$$t_B = -\frac{1}{F'(\xi_B)} = \frac{1}{|F'(\xi_B)|}.$$

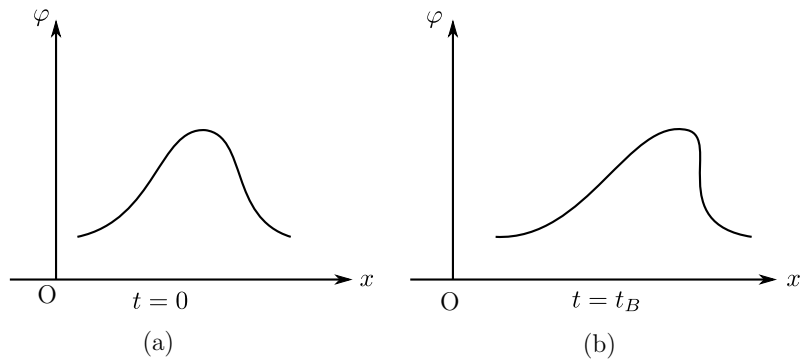

Figure 1.7:

In the  $x, t$ , plane the breaking can be seen as follows: since  $F'(\xi_B) < 0$ ,  $F$  is a decreasing function in a neighbourhood of  $\xi_B$  will have increasing slopes and therefore will converge giving a multivalued region.

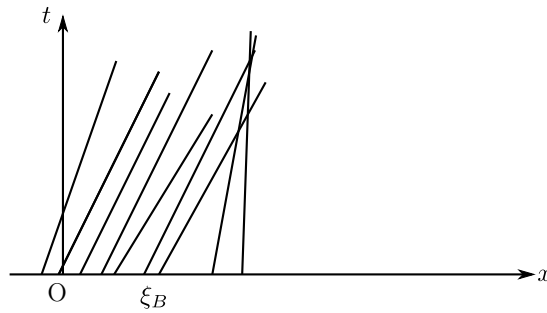

Figure 1.8:

14

From equations

$$\phi_t = -\frac{F(\xi)f'(\xi)}{tF'(\xi) + 1}, \phi_x = \frac{f'(\xi)}{tF'(\xi) + 1},$$

we see that  $\phi_t, \phi_x$  will become infinite at the time of breaking.

In order to understand the physical meaning of breaking and methods used to correct the solution, we need to look at specific physical problem.

#### Problem on method of characteristics.

Solve the following:

1.  $\phi_t + e^{-t}\phi_x = 0$  in  $t > 0, -\infty < x < \infty,$   
 $t = 0 : \phi = \frac{1}{1 + x^2}$
2.  $\phi_t + C_0\phi_x + \alpha\phi = 0$  in  $t > 0, -\infty < x < \infty,$   
 $t = 0 : \phi = f(x)$   
 $(\alpha \text{ and } C_0 \text{ positive constants})$
3.  $x^2\phi_t + \phi_x + t\phi = 0$  in  $x > 0, -\infty < t < \infty,$   
 $x = 0 : \phi = \Phi(t)$
4. Some equation as (3), but region  $x > 0, t > 0,$   
 $t = 0 : \phi = f(x), x > 0,$   
 $x = 0 : \phi = \Phi(t), t > 0,$

15

5.  $\phi_t + \phi\phi_x + \alpha\phi = 0$  in  $t > 0$ ,  $-\infty < x < \infty$ ,

$t = 0 : \phi = f(x)$  as shown in Fig. 1.6.

$\alpha$  is a positive constant.

Show that breaking need not always occur; i.e. solution is singlevalued for all  $t$  in some cases.



## Chapter 2

### Examples

WE NOW DESCRIBE some problems which lead to the non-linear 16 equation

$$\phi_t + c(\phi)\phi_x = 0.$$

In most of the problems we relate two quantities:  $\rho(x, t)$  which is the density of something per unit length and  $q(x, t)$  which is the flow per unit time. If the ‘something’ is conserved, then for a section  $x_2 \leq x \leq x_1$  we have the conservation equation

$$(2.1) \quad \frac{d}{dt} \int_{x_2}^{x_1} \rho dx + q(x_1, t) - q(x_2, t) = 0.$$

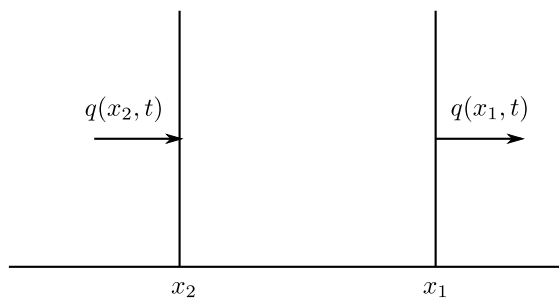

Figure 2.1:

If  $\rho$  and  $q$  are continuously differentiable then in the limit  $x_1 \rightarrow x_2$ , equation (2.1) becomes

$$(2.2) \quad \frac{\partial \rho}{\partial t} + \frac{\partial q}{\partial x} = 0.$$

If there exists also a functional relation  $q = Q(\rho)$  (this is so to a first approximation in many cases) then (2.2) can be written as

$$(2.3) \quad \rho_t + c(\rho)\rho_x = 0,$$

17 where  $c(\rho) = Q'(\rho)$ .

We will now give some specific examples.

## 2.1 Traffic Flow

We consider the flow of cars on a long highway. Here  $\rho$  will be the number of cars per unit length. Let  $v$  be the average local velocity of the cars. Then  $q$ , the flow per unit time, is given by  $q = \rho v$ . For a long section of highway with no exits or entrances the cars are conserved so that (2.1) holds. It also seems reasonable to assume that on the average  $v$  is a function of  $\rho$  to a first approximation. Hence  $\rho$  satisfies (2.3). The velocity  $v$  will be a decreasing function  $V(\rho)$ , and  $Q(\rho) = \rho V(\rho)$ . When the density is small the velocity will be some upper limiting value, and when the density is maximum the velocity will be zero. Therefore the graph of  $V$  will take a form as shown in the figure 2.2.

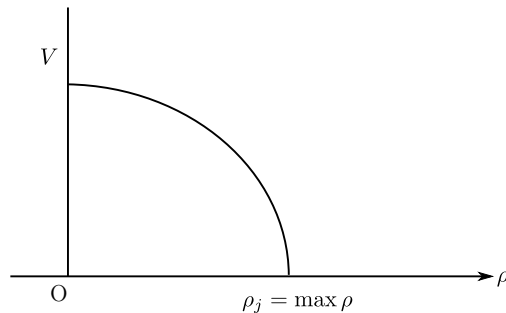

Figure 2.2:

Since  $q = Q(\rho) = \rho V$ , there will be no flow when the velocity is maximum (i.e.  $\rho = 0$ ) and when  $\rho$  is maximum (i.e.  $V = 0$ ). Hence the graph of  $Q(\rho)$  will look like the figure 2.3. 18

It was found in one set of observations on U.S. highways that the maximum density is approximately 225 vehicles per mile (per traffic lane), and the maximum flow is approximately 1500 vehicles per hour. When the flow  $q$  is maximum the density is found to be around 80 vehicles per mile.

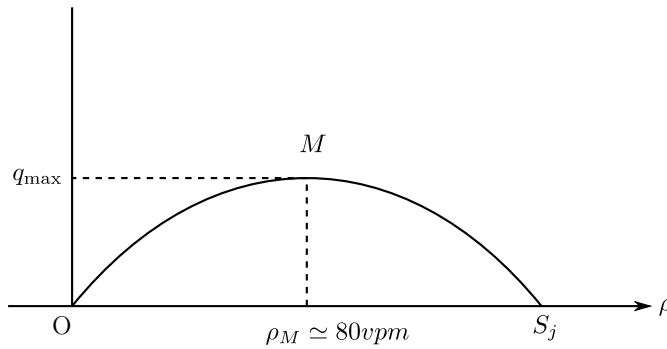

Figure 2.3:

The propagation speed for the wave is  $c(\rho) = Q'(\rho) = V(\rho) + \frac{dV}{d\rho}$ . Since  $V$  is a decreasing function of  $\rho$ ,  $\frac{dV}{d\rho} < 0$ . Thus  $c(\rho) < V(\rho)$  i.e. the propagation velocity is less than the average velocity. Relative to individual cars the waves arrive from ahead.

Referring to the  $Q(\rho)$  diagram decreasing in  $[\rho_M, \rho_j]$ ,  $Q$  attains a maximum at  $\rho_M$ . Therefore  $c(\rho) = Q'(\rho)$  is positive in  $[0, \rho_M)$ , zero at  $\rho_M$  and negative in  $(\rho_M, \rho_j]$ . That is waves move forward relative to the highway in  $[0, \rho_M)$ , are stationary at  $\rho_M$  and move backward in  $(\rho_M, \rho_j]$ .

Greenberg in 1959, found a good fit with data for the Lincoln Tunnel in New York by taking

$$Q(\rho) = a\rho \log(\rho_j/\rho)$$

with  $a = 17.2 \text{ mph}$  and  $\rho_j = 228 \text{ vpm}$ . For this formula,

$$V(\rho) = \frac{Q(\rho)}{\rho} = a \log(\rho_j/\rho)$$

and  $c(\rho) = Q'(\rho) = a(\log(\rho_j/\rho) - 1) = V(\rho) - a$ . Hence the relative propagation velocity is equal to the constant 'a' at all densities and this relative speed is about 17 mph. The values of  $\rho_M$  and  $q_{\max}$  are:

$$\begin{aligned} \rho_M &= 83 \text{ vpm} & \text{and} & & q_{\max} &= 1430 \text{ vph} \\ (\rho_M &= \rho_j/e & \text{and} & & q_{\max} &= a\rho_j/e) \end{aligned}$$

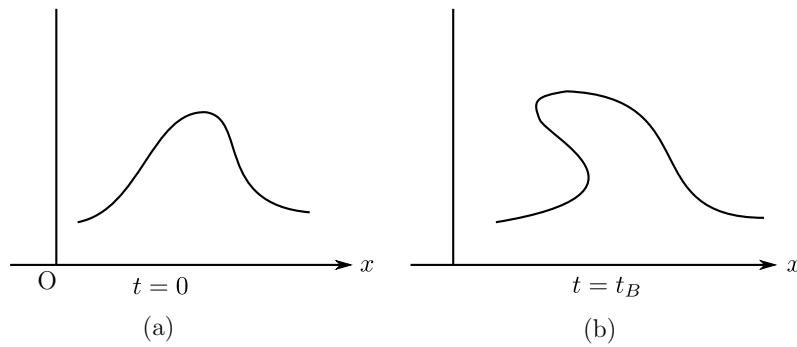

Figure 2.4:

Let  $f$  be the initial distribution function as shown in the figure 2.4(a). Since  $c'(\rho) = V'(\rho) < 0$ , breaking occurs on the left. The solution of the problem is

$$\begin{aligned} \rho &= \rho(\xi) \\ x &= tF(\xi) + \xi \quad \text{where} \quad F(\xi) = c(f(\xi)) \end{aligned}$$

Breaking occurs when  $F'(\xi) < 0$ . But

$$F'(\xi) = c'(f(\xi)) \cdot f'(\xi) < 0 \quad \text{iff} \quad f'(\xi) > 0$$

i.e. when  $f$  is increasing.

In most other examples  $c'(\rho) > 0$ , so that a wave of increasing density breaks at the front.

## 2.2 Flood waves in rivers

20

Another example comes from an approximate theory for flood waves in rivers. For simplicity we take a rectangular channel of constant breadth, and assume that the disturbance is roughly the same across the breadth. Then the height  $h(x, t)$  plays the role of ‘density’. Let  $\rho$  be the flow per unit breadth, per unit time. Then from the conservation law we have

$$\frac{d}{dt} \int_{x_2}^{x_1} h dx + q_1 - q_2 = 0$$

Taking the limit  $x_2 \rightarrow x_1$ , we obtain

$$h_t + q_x = 0$$

A functional relation  $q = Q(h)$  is a good first approximation when the river is flooding. Therefore the governing equation is

$$h_t + c(h)h_x = 0$$

where  $c(h) = \frac{dQ}{dh}$ .

This formula for the wave speed was first proposed by Kleitz and Seddon. The function  $Q(h)$  is determined from a balance between gravitational acceleration down the sloping bed and frictional effects. When the function is given by the Chezy formula  $V\alpha h^{1/2}$  i.e.  $V = kh^{1/2}$ , where  $V$  is the velocity of the flow, we have

$$Q(h) = Vh = kh^{3/2}$$

and  $c(h) = \frac{3}{2}kh^{1/2} = \frac{3}{2}V$ . According to this, flood waves move roughly half as fast again as the stream. 21

## 2.3 Chemical exchange processes

In chemical engineering various processes concern a flow of fluid carrying some substances or particles through a solid bed. In the process

some part of the material in the fluid will be deposited on the solid bed. In a simple formulation we assume that the fluid has constant velocity  $V$ . We take density to be  $\rho = \rho_f + \rho_s$ , where  $\rho_f$  is the density of the substance concerned in the fluid and  $\rho_s$  is the density of the material deposited on solid bed. The total flow of material across any section is

$$q = \rho_f V.$$

The conservation equation becomes

$$(2.4) \quad \frac{\partial}{\partial t} (\rho_f + \rho_s) + V \frac{\partial \rho_f}{\partial x} = 0$$

To complete the system we require more equations. When the changes are slow we can assume to a first approximation that is a quasi - equilibrium between the amounts in the fluid and on the solid and that this balance leads to a functional relation  $\rho_s = R(\rho_f)$ . Then (2.4) becomes

$$\frac{\partial}{\partial t} \rho_f + c(\rho_f) \frac{\partial}{\partial x} \rho_f = 0$$

where

$$c(\rho_f) = \frac{V}{1 + R'(\rho_f)}.$$

- 22 The relation between  $\rho_f$  and  $\rho_s$  is discussed in more detail below (see 3.6).

## 2.4 Glaciers

Nye (1960, 1963) has pointed out that the ideas on flood waves apply equally to the study of waves on glaciers and has developed the particular aspects that are most important there. He refers to Finsterwalder (1907) for the first studies of wave motion on glaciers and to independent formulations by Weertman (1958). For order of magnitude purposes, one may take

$$Q(h) \propto h^N$$

with  $N$  roughly in the range 3 to 5. The propagation speed is

$$c = \frac{dQ}{dh} = Nv,$$

where  $v$  is the average velocity  $Q/h$ . Thus the waves move about three to five times faster than the average flow velocity. Typical velocities are of the order of 10 to 100 metres per year.

An interesting question considered by Nye is the effect of periodic accumulation and evaporation of the ice; depending on the period, this may refer either to seasonal or climatic changes. To do this, a prescribed source term  $f(x, t)$  is added to the continuity equation; that is one takes

$$h_t + q_x = f(x, t), \quad q = Q(h, x).$$

The consequences are determined from integration of the characteristic equations

$$\begin{aligned} \frac{dh}{dt} &= f(x, t) - Q_x(h, x), \\ \frac{dx}{dt} &= Q_h(h, x). \end{aligned}$$

23

The main results in that parts of the glacier may be very sensitive, and relatively rapid local changes can be triggered by the source term.

## 2.5 Erosion

Erosion in mountains was studied by Luke. Let  $h(x, t)$  be the height of the mountain from the ground level. It is reasonable to assume a functional relation between  $h_t$  and  $h_x$  as:

$$h_t = -Q(h_x).$$

(When the slope of the mountain is greater, it is more vulnerable to erosion).

Let

$$(2.5) \quad s = h_x$$

Then differentiating (2.5) with respect to  $x$  we obtain

$$h_{tx} = -Q'(h_x) h_{xx},$$

that is  $\frac{\partial s}{\partial t} + Q'(s) \frac{\partial s}{\partial x} = 0$ , which is our one dimensional non-linear wave equation with  $c(s) = Q'(s)$ . When breaking occurs we introduce discontinuities in  $s$ , which is  $h_x$ , and  $h$  remains continuous but with a sharp corner.



## Chapter 3

# Shock Waves

WE OBTAINED THE solution of the equation

24

$$\rho_t + q_x = 0$$

on the assumptions

- (1)  $\rho$  and  $q$  are continuously differentiable.
- (2) There exists a functional relation between  $q$  and  $\rho$ ; that is  $q = Q(\rho)$ .

In our discussions we found the phenomena of breaking in some cases. At the time of breaking we have to reconsider our assumptions. We will approach this in two directions.

- (i) We still assume a functional relation between  $q$  and  $\rho$  i.e.  $q = Q(\rho)$ , but allow jump discontinuities for  $\rho$  and  $q$ .
- (ii) We assume  $\rho$  and  $q$  are continuously differentiable and  $q$  is a function of  $\rho$  and  $\rho_x$ . For simplicity we take this in the form

$$q = Q(\rho) - \nu\rho_x$$

where  $\nu > 0$ .

### 3.1 Discontinuous shocks

We now work with the assumption (i). Our conservation equation in the integrated form:

$$\frac{d}{dt} \int_{x_2}^{x_1} \rho dx + q_1 - q_2 = 0$$

25 still holds even if  $\rho$  and  $q$  have jump discontinuities.

We now assume that the function  $\rho(x, t)$  has a jump discontinuity at  $x = s(t)$ , where  $s$  is a continuously differentiable function of  $t$ .

At time  $t$ , let  $x_1 > s(t) > x_2$  and  $U(t) = s(t) = \frac{ds}{dt}$ . The conservation equation can now be written as

$$\frac{d}{dt} \left\{ \int_{x_2}^{s(t)-} \rho dx + \int_{s(t)+}^{x_1} \rho dx \right\} + q_1 - q_2 = 0$$

This implies

$$\begin{aligned} & \int_{x_2}^{s(t)-} \rho_t dx + s(t) \rho(s(t)-, t) + \int_{s(t)+}^{x_1} \rho_t dx \\ & - s(t) \rho(s(t)+, t) + q(x_1, t) - q(x_2, t) = 0 \end{aligned}$$

Taking the limits  $x_2 \rightarrow s(t)-$  and  $x_1 \rightarrow s(t)+$  we obtain

$$-s(t)(\rho(s(t)+, t) - \rho(s(t)-, t)) + (q(s(t)+, t) - q(s(t)-, t)) = 0$$

We symbolically write this as

$$(3.1) \quad -U[\rho] + [q] = 0$$

where  $[.]$  denotes the jump.

Equation (3.1) is called the 'shock condition'.

The basic problem can now be written as

$$(3.2) \quad \begin{aligned} \rho_t + q_x &= 0, & \text{at points of continuity} \\ -U[\rho] + [q] &= 0, & \text{at discontinuity points} \end{aligned}$$

There is a nice correspondence between the differential equation and the shock condition.

$$\frac{\partial}{\partial t} \leftrightarrow -U[.], \quad \frac{\partial}{\partial x} \leftrightarrow [.]$$

26

The shock condition can also be written as

$$(3.3) \quad U = \frac{q_2 - q_1}{\rho_2 - \rho_1} = \frac{Q(\rho_2) - Q(\rho_1)}{\rho_2 - \rho_1}$$

where the suffixes 1 and 2 stand for the arguments  $(s(t)+, t)$  and  $(s(t)-, t)$  respectively.

It is important to note that the **direct** association of a jump condition with a differential equation in conservation form is not unique. For example, consider

$$(3.4) \quad \rho_t + \rho \rho_x = 0$$

This can be written as  $\rho_t + (\frac{1}{2}\rho^2)_x = 0$ , and the corresponding jump condition is

$$(3.5) \quad -U[\rho] + \left[ \frac{1}{2}\rho^2 \right] = 0$$

However, equation (3.4) can also be written as

$$\left( \frac{1}{2}\rho^2 \right)_t + \left( \frac{1}{3}\rho^3 \right)_x = 0;$$

the associated shock condition would be

$$(3.6) \quad -U \left[ \frac{1}{2}\rho^2 \right] + \left[ \frac{1}{3}\rho^3 \right] = 0$$

Obviously (3.5) and (3.6) are different.

We have to choose the appropriate jump condition only from the physical considerations of the problem and the original **integrated** form of the conservation law.

We now give the simplest example in which a shock occurs.

**Example.** The simplest case in which breaking occurs will be

27

$$\rho_t + c(\rho)\rho_x = 0 \quad \text{in } t > 0, -\infty < x < \infty,$$

$$t = 0 : \rho = \begin{cases} \rho_2 & \text{if } x < 0 \\ \rho_1 & \text{if } x > 0, (\rho_2 > \rho_1) \end{cases}$$

with  $c'(\rho) > 0$

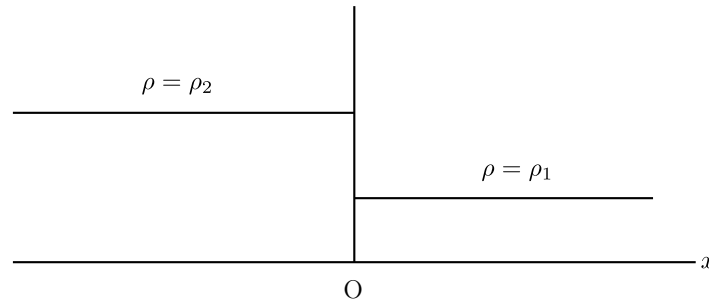

Figure 3.1:

In this case breaking will occur immediately. The proposed discontinuous solution is just a shock moving with velocity

$$U = \frac{Q(\rho_2) - Q(\rho_1)}{\rho_2 - \rho_1}$$

separating uniform regions  $\rho = \rho_1$  and  $\rho = \rho_2$  on the two sides.

### 3.2 Equal area rule

The general question of fitting in a discontinuous shock to replace a multivalued region can be answered elegantly by the following argument. The integrated form of the conservation equation, i.e. ,

$$\frac{d}{dt} \int_{x_2}^{x_1} \rho dx + q_1 - q_2 = 0,$$

28 holds for both the multivalued solution and the discontinuous solution. If we take the case of a single hump disturbance as shown in the figure 3.2(a), with  $\rho = \rho_0$  on both sides of the disturbance, and if we take  $x_1, x_2$  far away from the disturbance with  $q_1 = q_2 = Q(\rho_0)$ , then

$$\int_{x_2}^{x_1} \rho dx = \text{constant in time}$$

This is so for both the multivalued solution in figure 3.2(b) and the discontinuous solution in figure 3.2(c). Hence the position of the shock must be chosen to give equal areas  $A = B$  for the two lobes as shown in figure 3.2(d).

The analytic implementation of this construction is described in [1]

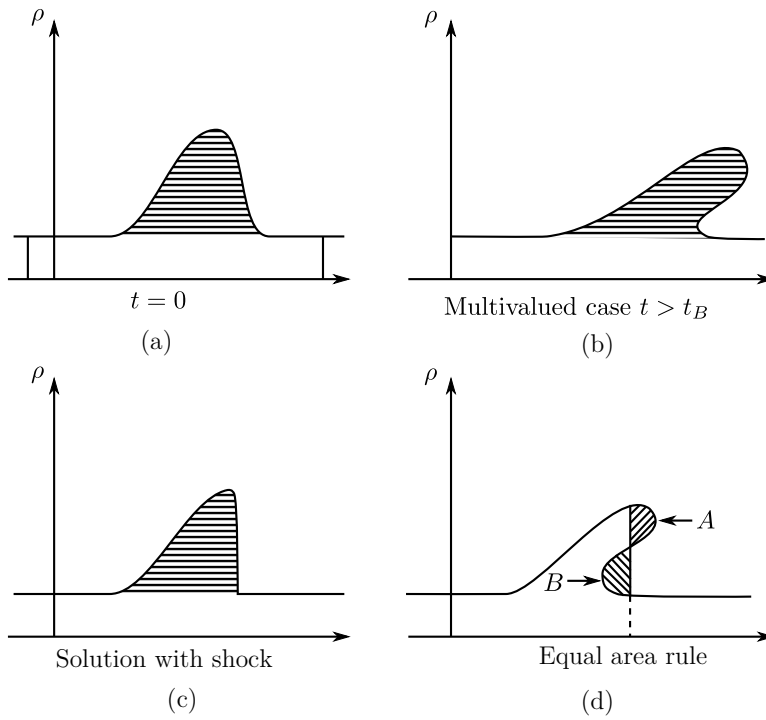

Figure 3.2:

### 3.3 Asymptotic behavior

29

We are interested in finding out what happens to the solution as  $t \rightarrow \infty$ , and this can be obtained directly without going through the previous construction in detail. We first study a special  $Q(\rho)$  which simplifies the results.

The equation is,

$$(3.7) \quad \rho_t + q_x = 0$$

with the shock condition

$$(3.8) \quad -U[\rho] + [q] = 0$$

If  $q = Q(\rho)$  and  $c(\rho) = Q'(\rho)$  then, as noted already, (3.7) can be written as

$$C_t + CC_x = 0, \quad \text{or} \quad C_t + \left(\frac{1}{2}C^2\right)_x = 0$$

where  $C(x, t) = c(\rho(x, t))$ . From the second form of the equation for  $C$ , we may be tempted to write the shock condition (3.8) as  $-U[C] + [\frac{1}{2}C^2] = 0$ . But this is not always true, i.e. conservation of  $\rho$  does not imply the conservation of  $C$ . However, when  $Q$  is quadratic, say,

$$Q(\rho) = \alpha\rho^2 + \beta\rho + \gamma$$

then conservation of  $\rho$  implies the conservation of  $C$ , since  $C$  is linear in  $\rho$ .

This can be easily checked as follows: We have

$$c(\rho) = Q'(\rho) = 2\alpha\rho + \beta;$$

by equation (3.8),

$$(3.9) \quad -U[\rho] + [\alpha\rho^2 + \beta\rho + \gamma] = 0$$

30

Now,

$$\begin{aligned} -U[C] + \frac{1}{2}[C^2] &= -U[2\alpha\rho + \beta] + \left[2\alpha^2\rho^2 + 2\alpha\beta\rho + \frac{1}{2}\beta^2\right] \\ &= 2\alpha\{-U[\rho] + [\alpha\rho^2 + \beta\rho + \gamma]\}, \end{aligned}$$

and this is seen to be zero by (3.9). (Here we have used  $[\beta] = [\frac{1}{2}\beta^2] = [\gamma] = 0$  since  $\beta$  and  $\gamma$  are constants).

In this case we can work with  $C$  alone and the shock condition is

$$U = \frac{c_1 + c_2}{2}$$

The initial value problem is

$$(3.10) \quad \left. \begin{aligned} C_t + CC_x &= 0, \quad t > 0, \quad -\infty < x < \infty \\ C &= F(x), \quad t = 0 : \quad -\infty < x < \infty. \end{aligned} \right\}$$

We will now consider the asymptotic behavior of a single hump, i.e.

$$F(\xi) = \begin{cases} c_0 & \text{in } x \leq a \\ g(x) & \text{in } [a, L] \\ c_0 & \text{in } x \geq L \end{cases}$$

where  $g$  is continuous in  $[a, L]$  with  $g(a) = g(L) = c_0$ , as shown in figure 3.2(a).

In this case breaking will occur at the front and we fit a shock to remove multivaluedness. As time increases, much of the initial detail is lost. As this process is continued, it is plausible to reason that the remaining disturbance becomes linear in  $x$ . In any event, there is such a simple solution with  $C = x/t$ . We propose, therefore, that the solution is 31

$$(3.11) \quad C = \begin{cases} c_0, & x \leq c_0 t \\ \frac{x}{t}, & c_0 t \leq x \leq s(t), \\ c_0, & s(t) < x, \end{cases}$$

where  $x = s(t)$  is the position of the shock still to be determined.

The shock condition is  $U = \frac{c_1 + c_2}{2}$ ; therefore, since  $c_1 = c_0, c_2 = s(t)/t$ , we have

$$(3.12) \quad \frac{ds}{dt} = \frac{1}{2} \left\{ c_0 + \frac{s}{t} \right\}$$

The solution of this is easily found to be

$$S = c_0 t + bt^{1/2},$$

where  $b$  is a constant. So we have a triangular wave for  $C$  as shown in figure 3.3. The area of the triangle is  $\frac{1}{2}b^2$  and this must remain equal to the area  $A$  under the initial hump. Hence  $b = (2A)^{1/2}$ . Only the area of the initial wave appears in this final asymptotic solution; all other details are lost. It should be remarked that this behavior is completely different from linear theory.

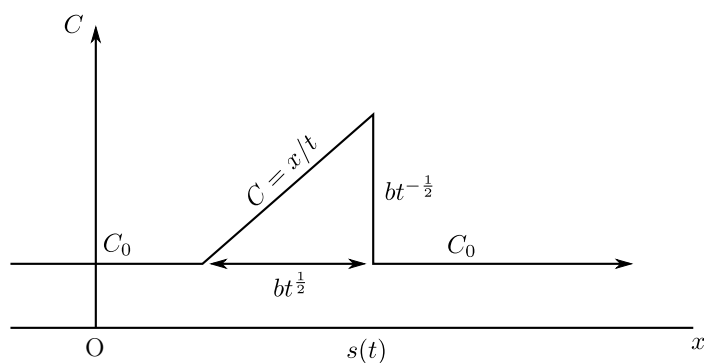

Figure 3.3:

### 32 Problems.

1. Solve

$$\left(\frac{\partial}{\partial t} + u\frac{\partial}{\partial x}\right)\left(\frac{\partial}{\partial t} + u\frac{\partial}{\partial x}\right)u + u = 0, \quad t > 0, \quad -\infty < x < \infty,$$

$$t = 0 : \begin{cases} u = 0, \\ u_t = a \sin kx, \quad -\infty < x < \infty \end{cases}$$

using the method of characteristics. Find also the time of first occurrence of singularities.



2. Solve

$$\rho_t + \rho\rho_x = 0, \quad t > 0, \quad -\infty < x < \infty,$$

$$t = 0 : \rho = \begin{cases} 0 & \text{in } x \leq 0 \\ x & \text{in } 0 \leq x \leq \frac{1}{2} \\ 1 - x & \text{in } \frac{1}{2} \leq x \leq 1 \\ 0 & \text{in } x \geq 1 \end{cases}$$

Find the first time of breaking and the point at which it breaks. Fit a shock to this and find the shock velocity.

3. solve

$$C_t + CC_x = 0, \quad t > 0, \quad -\infty < x < \infty,$$

$$t = 0 : c = \begin{cases} c_0 & \text{in } x \leq 0 \\ f(x) & \text{in } [0, 1] \\ c_0 & \text{in } x \geq 1 \end{cases}$$

where  $f(x)$  is continuous in  $[0, 1]$  with  $f(0) = f(1) = c_0$ ,  $f$  decreases in  $[0, \frac{1}{2}]$  and increases in  $[\frac{1}{2}, 1]$ . Show that breaking occurs. Describe the asymptotic behavior of the solution including the shock. 33

4. The equation is the same as in the problem 3. Now the initial distribution is

$$t = 0 : f = \begin{cases} C_0 & \text{in } x \leq -1 \\ g(x) & \text{in } [-1, 1] \\ C_0 & \text{in } x \geq 1 \end{cases}$$

where  $g$  is a continuous function with  $g(0) = g(-1) = g(1) = C_0$ ,  $g$  is decreasing in  $[-1, \frac{1}{2}]$  and increasing in  $[-\frac{1}{2}, \frac{1}{2}]$  and again decreasing in  $[\frac{1}{2}, 1]$ . Fit shocks wherever necessary and find the asymptotic behavior of the solution. The asymptotic form is called an N-wave.

5. Solve

$$C_t + CC_x = 0, \quad t > 0, \quad -\infty < x < \infty,$$

$$t = 0 : C = F(\xi) = C_0 + a \sin \frac{2\pi\xi}{\lambda}$$

Use the fact that  $C = \frac{x}{t}$  is a solution of the equation to describe the asymptotic behavior of the solution. Deduce that the asymptotic solution is independent of 'a' and that the shock decays like  $t^{-1}$  rather than  $t^{1/2}$ . Note that the area under the initial curve in the left interval  $[0, \lambda/2]$  is not preserved.

6. Assuming that shocks are only required when breaking occurs show that the shock velocity lies between  $C_1$  and  $C_2$ .

### 3.4 Shock structure

34 In the first approach to resolve breaking we have assumed a functional relation in  $\rho$  and  $q$  with appropriate shock conditions. Now we consider the second approach, namely that  $q$  and  $\rho$  are continuously differentiable but that  $q$  is a function of  $\rho$  and  $\rho_x$ . For simplicity we take

$$(3.13) \quad q = Q(\rho) - \nu\rho_x$$

where  $\nu > 0$ . (Here the sign of  $\nu$  is important). When  $\rho_x$  is small,  $q = Q(\rho)$  is a good approximation; but near breaking where  $\rho_x$  is large, (3.13) gives a better approximation. A motivation for (3.13) can be seen from traffic flow. In traffic flow, the density  $\rho$  is the number of cars per unit length. When the density is increasing ahead,  $\rho_x > 0$ , one expects the drivers to adjust the speed a little below equilibrium  $q = Q(\rho)$ , and when  $\rho_x < 0$  perhaps a little above. This is represented by the extra term  $\nu\rho_x$  in (3.13). The other examples in chapter have similar correction terms in an improved description.

The conservation equation is

$$\frac{d}{dt} \int_{x_2}^{x_1} \rho dx + q_1 - q_2 = 0$$

and for differentiable  $\rho, q$  we have the differential equation

$$(3.14) \quad \rho_t + q_x = 0$$

as before. Using (3.13), (3.14) becomes

$$(3.15) \quad \rho_t + c(\rho)\rho_x = \nu\rho_{xx}$$

where  $c(\rho) = Q'(\rho)$ . Before considering the solution of (3.15) in detail, we note the general qualitative effects of the terms  $c(\rho)\rho_x$  and  $\nu\rho_{xx}$ . To see this we take the initial function to be a step function. 35

$$(3.16) \quad t = 0 : \rho = \begin{cases} \rho_2 & \text{if } x < 0 \\ \rho_1 & \text{if } x > 0 \end{cases}$$

with  $\rho_2 > \rho_1$ . Omitting the term  $c(\rho)\rho_x$ , the equation (3.15) becomes the heat equation,

$$(3.17) \quad \rho_t = \nu\rho_{xx}$$

The solution to (3.17) with the initial conditions (3.16) is

$$(3.18) \quad \rho = \rho_2 - \frac{\rho_2 - \rho_1}{\sqrt{\pi}} \int_{-\infty}^{\frac{x}{\sqrt{4\nu t}}} e^{-\zeta^2} d\zeta$$

This shows that the effect of the term  $\nu\rho_{xx}$  is to smooth out the initial distribution like  $(\nu t)^{-1/2}$ .

Neglecting the term  $\nu\rho_{xx}$  in (3.15) we have the immediate breaking discussed earlier.

Thus our equation (3.15) will have both the effects, namely stretching and steepening, and it seems reasonable that there will be solutions having the balance between the two. We will now look for simple solutions to test the idea. Let us assume that

$$(3.19) \quad \rho = \rho(X), X = x - Ut$$

is a solution of (3.15), where  $U$  is a constant. We also assume that

$$(3.20) \quad \left. \begin{aligned} \rho &\rightarrow \rho_1 & \text{as } x &\rightarrow \infty \\ \rho &\rightarrow \rho_2 & \text{as } x &\rightarrow -\infty \\ \text{and } \rho_x &\rightarrow 0 & \text{as } x &\rightarrow \pm\infty \end{aligned} \right\}$$

Now (3.15) becomes

$$(3.21) \quad c(\rho)\rho_X - U\rho_X = v\rho_{XX}$$

Using  $c(\rho) = Q'(\rho)$  and integrating (3.21) with reference to  $X$  we obtain

$$(3.22) \quad Q(\rho) - U\rho + A = v\rho_X,$$

where  $A$  is the constant of integration. Equations (3.22) and (3.20) imply

$$U = \frac{Q(\rho_2) - Q(\rho_1)}{\rho_2 - \rho_1}$$

which is exactly the same as the shock velocity in the discontinuity theory. Equation (3.22) can be written as

$$\frac{1}{v} = \frac{1}{Q(\rho) - U\rho + A} \cdot \frac{d\rho}{dX}.$$

Integrating this with reference to  $X$  we get

$$(3.23) \quad \frac{X}{v} = \int \frac{d\rho}{Q(\rho) - U\rho + A}$$

Since  $\rho_1, \rho_2$  are zeroes of  $Q(\rho) - U\rho + A$  the integrals taken over the neighbourhoods of  $\rho_1, \rho_2$  diverge; so  $X \rightarrow \pm\infty$  as  $\rho \rightarrow \rho_1$  or  $\rho_2$ . This is consistent with our assumptions (3.20).

If  $c'(\rho) > 0$  then  $Q(\rho) \leq U\rho - A$  in  $[\rho_1, \rho_2]$  and then by (3.22)  $\rho_X \leq 0$ . Hence  $\rho$  is decreasing and the solution can be schematically represented as in figure 3.4.

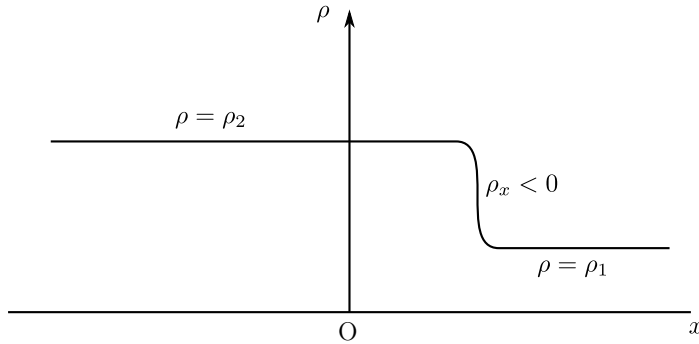

Figure 3.4:

An explicit solution for (3.15) and (3.16) can be obtained when  $Q$  is the quadratic

$$Q = \alpha\rho^2 + \beta\rho + \gamma$$

Then

$$Q(\rho) - U\rho + A = -\alpha(\rho - \rho_1), (\rho_2 - \rho),$$

and by (3.23)

$$\begin{aligned} \frac{X}{\nu} &= - \int \frac{d\rho}{\alpha(\rho_2 - \rho)(\rho - \rho_1)} \\ &= \frac{1}{\alpha(\rho_2 - \rho_1)} \log\left(\frac{\rho_2 - \rho}{\rho - \rho_1}\right). \end{aligned}$$

Hence we obtain a solution

$$(3.24) \quad \rho = \rho_1 + (\rho_2 - \rho_1) \frac{\exp(-(\rho_2 - \rho_1)\alpha X/\nu)}{1 + \exp(-(\rho_2 - \rho_1)\alpha X/\nu)}$$

When  $\nu$  is small, the transition region between  $\rho_1$  to  $\rho_2$  is very thin. This can be made more precise as follow  $s$ .

Consider the tangent through the point of inflexion of the curve  $\rho$  in the  $\rho - X$  Plane. Let it cut the lines  $\rho = \rho_1$ , and  $\rho = \rho_2$  at the points  $(X_1, \rho_1)$  and  $(X_2, \rho_2)$  respectively. The difference between  $X_1$  and  $X_2$  is called the 'shock thickness'. 38

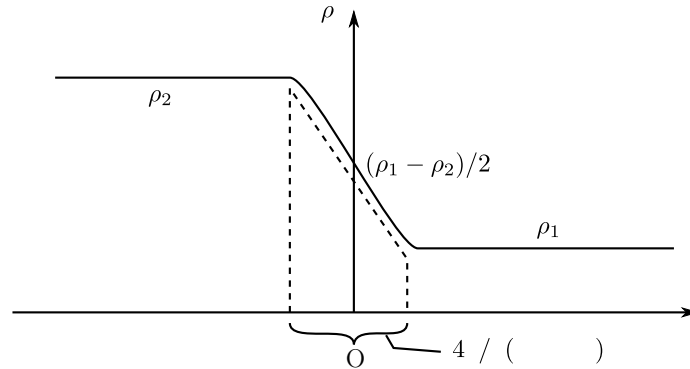

Figure 3.5:

In the particular case (3.24) we find the shock thickness to be  $4\nu/\alpha(\rho_2 - \rho_1)$ . From this we conclude that the thickness tends to zero as  $\nu$  tends to zero for fixed  $\rho_1, \rho_2$ . However, notice that for fixed  $\nu$  the thickness eventually increases as  $\rho_2 - \rho_1 \rightarrow 0$ .

In the improved theory this smooth, but rapid, transition layer replaces the discontinuous shock of the earlier theory. Similarly, we expect the discontinuities in more general solutions to be replaced by thin transition layers in the improved theory. This can be shown in full detail for the case of quadratic  $Q(\rho)$  as explained in the next section.

### 3.5 Burger's equation

Multiplying both sides of the equation (3.15) by  $c'(\rho)$  and manipulating we obtain

$$(3.25) \quad C_t + CC_x = \nu C_{xx} + \nu c''(\rho)\rho_x^2$$

39 In the special case when  $Q(\rho)$  is again the quadratic  $\alpha\rho^2 + \beta\rho + \gamma$  we have  $c''(\rho) = 0$ . Hence (3.25) becomes

$$(3.26) \quad C_t + CC_x = \nu C_{xx}$$

Equation (3.26) is called Burgers' equation. This equation is originally due to Bateman (1935) but Burgers gave special solutions to it in

1940 and emphasized its importance. In 1950–51 Cole and Holf worked independently on this and solved it explicitly. They introduced a non-linear transformation which converted (3.26) into the linear heat equation. We now give a brief account of this transformation.

First, if we introduce the variable

$$(3.27) \quad C = \Psi_x,$$

equation (3.26) becomes

$$\Psi_{xt} + \Psi_x \cdot \Psi_{xx} = \nu \Psi_{xxx}.$$

Integrating this with reference to  $x$  we obtain

$$(3.28) \quad \Psi_t + \frac{1}{2} \Psi_x^2 = \nu \Psi_{xx}.$$

The transformation

$$(3.29) \quad \Psi = -2\nu \log \phi$$

converts the equation (3.28) into the linear heat equation

$$(3.30) \quad \phi_t = \nu \phi_{xx}$$

The initial condition

$$t = 0 : C = F(x)$$

for (3.26) becomes

$$(3.31) \quad t = 0 : \phi = \phi(\eta) = \exp \left\{ -\frac{1}{2\nu} \int_0^\eta F(x) dx \right\}$$

Then the solution of (3.30) with the initial condition (3.31) is

40

$$\phi(x, t) = \frac{1}{\sqrt{4\pi\nu t}} \int_{-\infty}^{\infty} \Phi(\eta) \exp \left\{ -\frac{(x - \eta)^2}{4\nu t} \right\} d\eta$$

and therefore,

$$C(x, t) = \frac{\int_{-\infty}^{\infty} \frac{x-\eta}{t} \cdot \Phi(\eta) \exp\left\{-\frac{(x-\eta)^2}{4\nu t}\right\} d\eta}{\int_{-\infty}^{\infty} \Phi(\eta) \exp\left\{-\frac{(x-\eta)^2}{4t}\right\} d\eta}$$

The counterparts of the various solutions discussed in the discontinuity theory can be studied in this improved theory. Except for extremely weak shocks in certain cases, the only significant change (for small  $\nu$ ) is the smoothing of the shocks into thin transition layers. A full account is given in [1].

### 3.6 Chemical exchange processes; Thomas's equation

The situation is similar in chemical exchange processes. The conservation equation is

$$(3.32) \quad \frac{\partial}{\partial t} (\rho_f + \rho_s) + \frac{\partial}{\partial x} (V\rho_f) = 0$$

where  $\rho_f, \rho_s$  are as before (see section 2.3. We took

$$(3.33) \quad \rho_s = R(\rho_f)$$

to be an approximation and obtained the one dimensional non-linear wave equation. In many cases a more detailed description for the second relation between  $\rho_f$  and  $\rho_s$  is

$$(3.34) \quad \frac{\partial \rho_s}{\partial t} = K_1 (A - \rho_s) \rho_f - K_2 \rho_s (B - \rho_f)$$

- 41 where  $K_1, K_2, A, B$  are constants.  $A, B$  represent the saturation levels of the substance in the solid bed and the fluid respectively.

An approximation of the form (3.33) is obtained from (3.34) by neglecting the term  $\frac{\partial \rho_s}{\partial t}$ . We will work with the 'improved theory' provided by (3.34).



Thomas (1945) gave transformations to convert (3.32) into a linear equation.

**Step 1.** By the transformation

$$(3.35) \quad \tau = t - \frac{x}{V}, \sigma = \frac{x}{V}$$

(3.32) and (3.34) become

$$(3.36) \quad \frac{\partial \rho_f}{\partial \sigma} + \frac{\partial \rho_s}{\partial \tau} = 0$$

$$(3.37) \quad \text{and} \quad \frac{\partial \rho_s}{\partial \tau} = \alpha \rho_f - \beta \rho_s - \gamma \rho_s \rho_f$$

where  $\alpha, \beta, \gamma$  are constants.

**Step 2.** Consider now the transformation

$$(3.38) \quad \rho_f = \Psi_\tau, \rho_s = -\Psi_\sigma$$

Then (3.36) is satisfied identically, and (3.37) becomes

$$(3.39) \quad \Psi_{\sigma\tau} + \alpha \Psi_\tau + \beta \Psi_\sigma + \gamma \Psi_\sigma \Psi_\tau = 0$$

**Step 3.** The final step is to introduce the transformation

$$(3.40) \quad \Psi = \frac{l}{\gamma} \log \chi,$$

and this is the crucial one. Then (3.39) reduces to

42

$$(3.41) \quad \chi_{\sigma\tau} + \alpha \chi_\tau + \beta \chi_\sigma = 0$$

which is linear and can be solved by standard methods. Again various questions in the discontinuity theory can be viewed from the improved description.



## Chapter 4

# A Second Order System; Shallow Water Waves

43

THE EXTENSION OF the ideas presented so far to higher order systems can be adequately explained on a typical example. We shall use the so called shallow water wave theory for this purpose, although the pioneering work was originally done in gas dynamics.

### 4.1 The equations of shallow water theory

In shallow water theory the height  $h(x, t)$  of the water surface above the bottom is small relative to the typical wave lengths; it is called shallow water theory or long wave theory depending on which aspects one wants to stress.

We take the bottom to be horizontal and neglect friction. Let the density of the water be normalized to unity and let the width be one unit.

Let  $u(x, t)$  be the velocity,  $p_0$  the atmospheric pressure and  $(p_0 + p'(x, t))$  the pressure in the fluid. In every section  $x_2 \leq x \leq x_1$  the mass

is conserved, i.e.

$$\frac{d}{dt} \int_{x_2}^{x_1} h(x, t) dx + q_1 - q_2 = 0,$$

where the flow  $q = uh$ .

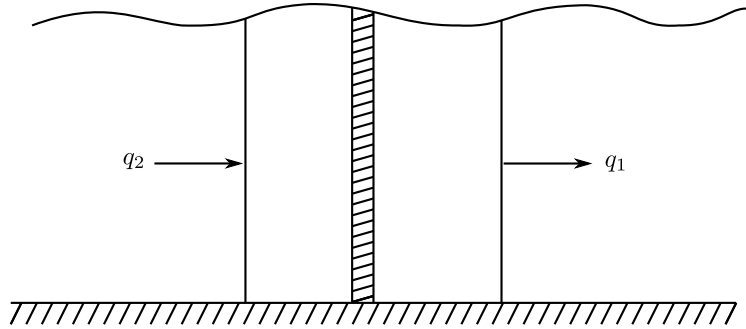

Figure 4.1:

44

Taking the limit  $x_2 \rightarrow x_1$ , we obtain

$$(4.1) \quad \begin{aligned} h_t + q_x &= 0, \\ \text{i.e.} \quad h_t + (uh)_x &= 0 \end{aligned}$$

This time a second relation between  $u$  and  $h$  is obtained from the conservation of the momentum in the  $x$ -direction. If we consider a section  $x_2 \leq x \leq x_1$ , as shown in figure 4.1, a constant pressure  $p_0$  acting all around the boundary, including free surface and bottom, is self-equilibrating. Therefore, only the excess pressure  $p'$  contributes to the momentum balance. If  $P(x, t)$  denotes the total excess pressure,

$$P = \int_0^h p' dy$$

acting across a vertical section, the momentum equation is then

$$(4.2) \quad \frac{d}{dt} \int_{x_2}^{x_1} hu \, dx = hu^2 \Big|_{x=x_2} - hu^2 \Big|_{x=x_1} + P_2 - P_1$$

where  $P_i = P(x_i, t)$ ,  $i = 1, 2$ .

The term in the left hand side of (4.2) is the total rate of change of momentum in the section  $x_2 \leq x \leq x_1$ , and  $hu^2 \Big|_{x=x_i}$ , on the right, denotes the momentum transport across the surface through  $x = x_i$  ( $i = 1, 2$ ). 45

The basic assumption in shallow water theory is that the pressure is hydrostatic, i.e.

$$(4.3) \quad \frac{\partial p}{\partial y} = -g$$

where  $g$  is the acceleration due to gravity.

Integrating (4.3) and assuming the condition  $p = p_0$  at the top  $y = h$ , we obtain

$$p = p_0 + g(h - y).$$

Hence the total excess pressure is

$$(4.4) \quad P = \int_0^h g(h - y) \, dy = \frac{1}{2} gh^2$$

Equations (4.2) and (4.4) yield

$$(4.5) \quad \frac{d}{dt} \int_{x_2}^{x_1} hu \, dx + \left[ hu^2 + \frac{1}{2} gh^2 \right]_{x_2}^{x_1} = 0$$

The conservation form should be noted.

In the case of river flow discussed earlier, there would also be further terms on the right hand side of (4.5) due to the slope effect and friction; the slope is now omitted and frictional effects are neglected.

In the limit  $x_2 \rightarrow x_1$ , (4.5) becomes

$$(4.6) \quad (hu)_t + \left( hu^2 + \frac{1}{2} gh^2 \right)_x = 0$$

Equations (4.1) and (4.6) provide the system for the determination of  $u$  and  $h$ .

46 If  $h$  and  $u$  have jump discontinuities, the shock conditions corresponding to (4.1) and (4.6) (but deduced basically from the original integrated form) are

$$\begin{aligned} -U[h] + [uh] &= 0 \\ -U[uh] + \left[ hu^2 + \frac{1}{2} gh^2 \right] &= 0 \end{aligned}$$

respectively, where  $U$  is the shock velocity.

Using equations (4.1) in (4.6) we obtain

$$(4.7) \quad u_t + uu_x + gh_x = 0;$$

equation (4.1) can be written as

$$(4.8) \quad h_t + uh_x + hu_x = 0$$

## 4.2 Simple waves

Each of the conservation equations (4.1) and (4.6) takes our earlier form

$$\rho_t + q_x = 0.$$

In those earlier cases, a relation  $q = Q(\rho)$  was provided in the basic formulation. In the present case, we might ask in relation to (4.1) whether there are solutions in which  $q = uh$  is a function of  $h$ , where the appropriate functional relation is provided not from outside observations but from the second equation (4.6). We might equally well ask with respect to (4.6) whether there are solutions in which  $hu^2 + \frac{1}{2} gh^2$  is a function of  $hu$ , where the functional relation is provided by (4.1). The

two are equivalent and come down to the question of whether there are solutions in which, say,  $h$  is a function of  $u$ . We try

$$h = H(u),$$

and consider the consistency of the two equations. We use the simplified equations (4.7) and (4.8) for the actual substitution. (This approach is equivalent to Earnshaw's approach in gas dynamics). 47

After the substitution  $h = H(u)$ , we have

$$(4.7)' \quad u_t + uu_x + gH'(u)u_x = 0$$

$$(4.8)' \quad u_t + uu_x + \frac{H(u)}{H'(u)}u_x = 0$$

For consistency we require (4.8)'

$$gH'(u) = \frac{H(u)}{H'(u)},$$

which implies

$$(4.9) \quad \sqrt{gH}(u) = \pm \sqrt{H}$$

Taking the positive sign in (4.9) and integrating we obtain

$$(4.10) \quad 2\sqrt{gH} - 2\sqrt{gH_0} = u$$

where  $H_0 = H(0)$ . Then (4.7)' becomes

$$(4.11) \quad u_t + \left(u + \sqrt{gH}\right)u_x = 0$$

Thus  $u + \sqrt{gH}$  is the velocity of propagation. If we use (4.10) and set  $c_0 = \sqrt{gH_0}$ , equation (4.11) can be written as

$$(4.12) \quad u_t + \left(c_0 + \frac{3u}{2}\right)u_x = 0$$

We now have exactly the form discussed in the earlier chapters and can take over the results from there. Equation (4.10) is the functional relation equivalent to  $q = Q(\rho)$ .

If we take the negative sign in (4.9) we will obtain the relation

$$2\sqrt{gH} - 2\sqrt{gH_0} = -u$$

and the equation

48

$$u_t + (u - \sqrt{gH})u_x = 0$$

Each of these equations represents a so called 'simple wave'. The choice of signs in (4.10) and (4.12) correspond to wave moving to the right, the other signs correspond to one moving to the left.

**Example.** We consider a piston 'wave maker' moving parallel to the  $x$ -axis in the negative direction with given velocity. Initially when the piston is at rest, the water is at rest.

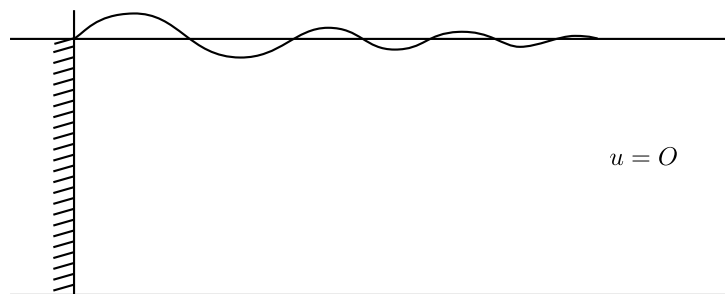

Figure 4.2:

The movement of the piston is represented in the  $x, t$  plane by the curve

$$x = X(t), u = \dot{X}(t),$$

where  $X(t)$  is a given function.



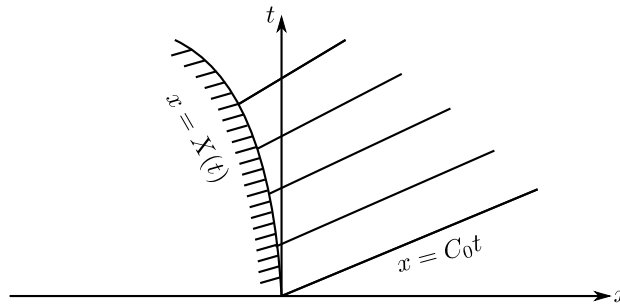

Figure 4.3:

The flow of water is governed by the equation

49

$$u_t + \left( c_0 + \frac{3u}{2} \right) u_x = 0,$$

since a wave moving to the right is produced.

Following the constructions of chapter 1, we choose a characteristic curve on which

$$\frac{dx}{dt} = c_0 + \frac{3u}{2}.$$

On this characteristic  $\frac{du}{dt} = 0$ ; therefore,  $u = \text{constant} = \dot{X}(\tau)$ , if the characteristic is passing through  $(X(\tau), \tau)$ . Therefore,  $\frac{dx}{dt} = c_0 + \frac{3}{2}\dot{X}(\tau)$ .

Integrating we obtain

$$x = X(\tau) + \left\{ c_0 + \frac{3}{2}\dot{X}(\tau) \right\} (t - \tau).$$

Hence the solution of the piston problem is

$$x = X(\tau) + \left\{ c_0 + \frac{3}{2}\dot{X}(\tau) \right\} (t - \tau),$$

$$u = \dot{X}(\tau),$$

where  $\tau$  is the characteristic parameter.

As in the previous cases, expansion waves (in this case  $\dot{X}(t) \leq 0$ ) do not break and the solution is valid for all  $t$ . On the other hand, moving

the piston forward or providing a positive acceleration, will produce a breaking wave. The inclusion of discontinuities based on the jump conditions (noted after equation (4.6)) is similar in spirit to the discussion of chapter 3, but is somewhat more complicated than before. The relation (4.10) is not strictly valid across discontinuities (note it was deduced from the differential equations), and approximations have to be made if the simple wave solutions are still used. (See [1] for details in the equivalent gas dynamics case).

### 4.3 Method of characteristics for a system

The above simple wave solutions provide an interesting approach and tie the discussion closely to the earlier material on a single equation. However, they are limited to waves moving in one direction only. We want to consider questions of waves moving in both directions and interacting with each other. We shall also find via Riemann's arguments a further understanding of the role of the simple waves.

Since we already know that  $c = \sqrt{gh}$  is a useful quantity here, we shall introduce it at the outset to simplify the expressions but it is in no way crucial. The equations (4.7) and (4.8) then become

$$(4.13) \quad u_t + uu_x + 2cc_x = 0,$$

$$(4.14) \quad c_t + uc_x + \frac{1}{2}cu_x = 0.$$

Now we note that each equation relates the directional derivatives of  $u$  and  $c$  for different directions. If the directions were the same we might make progress as in Chapter 1. But we can try linear combinations of (4.13) and (4.14) that have the desired property. Accordingly, we consider (4.13)  $+m$ . (4.14), where  $m$  is a quantity to be determined. We have

$$(4.15) \quad \{u_t + uu_x + 2cc_x\} + m \left\{ c_t + uc_x + \frac{1}{2}cu_x \right\} = 0$$

This will take the desired form,

$$\{u_t + vu_x\} + m\{c_t + vc_x\} = 0,$$

provided

$$u + \frac{m}{2}c = u + \frac{2c}{m} = v.$$

The latter gives  $m = \pm 2$ . Putting  $m = 2$  in (4.15) we have

$$(4.16) \quad (u + 2c)_t + (u + c)(u + 2c)_x = 0$$

We choose the  $\mathcal{C}_+$  characteristic to be

$$\mathcal{C}_+ : \frac{dx}{dt} = u + c$$

On  $\mathcal{C}_+$ , (4.16) becomes,  $\frac{d}{dt}(u + 2c) = 0$ , which implies  $u + 2c = \text{constant}$  on  $\mathcal{C}_+$ .

Taking  $m = -2$  in (4.15), we obtain

$$(4.17) \quad (u - 2c)_t + (u - c)(u - 2c)_x = 0$$

we choose the  $\mathcal{C}_-$  characteristic with the property

$$\mathcal{C}_- : \frac{dx}{dt} = u - c$$

Then equation (4.17) implies:

$$\begin{aligned} \text{On } \mathcal{C}_-, \frac{d}{dt}(u - 2c) &= 0, \\ \text{i.e. } u - 2c &= \text{constant on } \mathcal{C}_- \end{aligned}$$

Thus we obtain

$$\begin{aligned} u + 2c &= \text{constant on } \frac{dx}{dt} = u + c \\ u - 2c &= \text{constant on } \frac{dx}{dt} = u - c \end{aligned}$$

The constants may differ from characteristic to characteristic.

This is the method of characteristics for higher order systems. For an  $n^{\text{th}}$  order system of first order equations for  $u_1, \dots, u_n$ , one looks for a linear combination of the equations so that the directional derivatives of each  $u_i$  is the same. If there are  $n$  real different combinations with the characteristic property the system is **hyperbolic**.

In the present case the characteristic equations will be useful in various ways. We first reconsider the simple wave solutions.

#### 4.4 Riemann's argument for simple waves

We focus on the piston problem to show how the argument goes through and refer to figure 4.4.

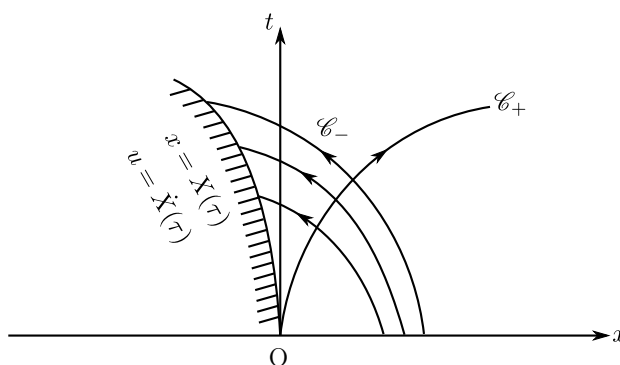

Figure 4.4:

Using the fact that  $u - c \leq u$  we can show that the  $\mathcal{C}_-$  characteristics cover the whole region  $\{(x, t) : t \geq 0, x \geq X(t)\}$ . On each  $\mathcal{C}_-$  we have  $u - 2c = \text{constant}$ ; from the initial condition

$$t = 0 : u = 0, c = c_0,$$

we find that  $u - 2c = -2c_0$ . But this is true for each  $\mathcal{C}_-$  with the **same** constant. Therefore

$$(4.18) \quad u - 2c = -2c_0$$

everywhere. This is exactly the relation (4.10): We could now refer to the previous discussion to complete the solution. To complete the solution in the present context, we use the  $\mathcal{C}_+$  relation

$$u + 2c = \text{constant on } \frac{dx}{dt} = u + c$$

From (4.18) this becomes

$$u = \text{constant on } \frac{dx}{dt} = c_0 + \frac{3}{2}u,$$

exactly the information contained in (4.12). We conclude that

$$(4.19) \quad \left. \begin{aligned} u &= \dot{X}(\tau) \\ x &= X(\tau) + \left\{ c_0 + \frac{3}{2}\dot{X}(\tau) \right\} (t - \tau) \end{aligned} \right\}$$

as before.

**Problem. Dam break.** In an idealization, the flow of water out of a dam is governed by the equations

$$\begin{aligned} u_t + uu_x + 2cc_x &= 0 \\ c_t + uc_x + \frac{1}{2}cu_x &= 0 \end{aligned}$$

with the initial conditions

$$t = 0 : \begin{cases} u = 0, & -\infty < x < \infty, \\ h = \begin{cases} h_1, & -\infty < x < 0, \\ 0, & 0 < x < \infty. \end{cases} \end{cases}$$

Find the solution. (There is no discontinuity and the final answer takes a simple explicit form).

## 4.5 Hodograph transformation

54

In the interaction of waves, where both families of characteristics carry nontrivial disturbances (i.e. (4.18) does not hold), solutions are much more difficult, and numerical methods are often used.

However, one alternative analytic method for studying the interaction of waves, or the two interacting families of waves produced by general initial conditions, is the ‘hodograph’ method. The equations are

$$(4.20) \quad \left. \begin{aligned} c_t + uc_x + \frac{1}{2} cu_x &= 0 \\ u_t + uu_x + 2cc_x &= 0 \end{aligned} \right\}$$

and we note that the coefficients are functions of the dependent variables only. We try to make use of that fact by interchanging the role of dependent and independent variables.

We have  $u = u(x, t)$ ,  $c = c(x, t)$  and consider the inverse functions

$$x = x(u, c), \quad t = t(u, c).$$

The term ‘hodograph’ is used when the velocities  $u$  and  $c$  are considered as independent variables. We have the relations

$$\begin{aligned} c_t &= -\frac{x_{tt}}{g}, \quad c_x = \frac{t_{tt}}{g}, \\ u_t &= \frac{x_{tc}}{g}, \quad u_x = -\frac{t_{tc}}{g}, \end{aligned}$$

where  $g = \frac{(c,t)}{(u,c)} = x_{tt}t_c - x_{tc}t_u$ .

55 For the system (4.20), the highly non-linear factor  $g$  cancels through and we have

$$(4.20)' \quad \left. \begin{aligned} x_u &= ut_u - \frac{1}{2} ct_c \\ x_c &= ut_c - 2ct_u \end{aligned} \right\}$$

Notice  $g$  would not cancel if there were undifferentiated terms. Equations (4.20)' are now linear and this offers considerable simplification.

Differentiating the first equation in (4.20)' with respect to  $c$ , partially, and the second one with respect to  $u$  and subtracting, we find

$$(4.21) \quad 4t_{uu} = t_{cc} + \frac{3}{c}t_c.$$

This is a linear equation for  $t(u, c)$  which can be solved by standard methods.

However, the difficulties in this method are:

- (1) The transformed boundary conditions in the  $u-c$  plane will sometimes be awkward.
- (2) When breaking occurs  $g = 0$ , corresponding to the multivaluedness, and fitting in shocks may sometimes be difficult in this plane.

For these reasons a numerical method is often preferred. However, in the case of waves on a sloping beach an analogous method has led to an extremely valuable solution; it will be described in section 5.4.

In that connection, a particularly elegant form of the transformation is useful and we note it here for the case of the horizontal bottom. We use the characteristic form

$$\begin{aligned} p = u + 2c &= \text{constant on } \frac{dx}{dt} = u + c \\ q = u - 2c &= \text{constant on } \frac{dx}{dt} = u - c. \end{aligned}$$

If  $p, q$  are used as variables, we can write

$$\begin{aligned} \frac{dx}{dt} &= u + c \\ \text{as } x_q &= (u + c)t_q, \end{aligned}$$

since  $p$  is a constant on that characteristic and  $q$  can be used as parameter. Similarly

$$x_p = (u - c)t_p.$$

We then substitute for  $u$  and  $c$  in terms of  $p$  and  $q$  to obtain

$$x_q = \frac{3p + q}{4}t_q, \quad x_p = \frac{p + 3q}{4}t_p$$

These are the linear hodograph equations equivalent to (4.20)'. Eliminating  $x$ , we have

$$2(q - p)t_{pq} - 3(t_q - t_p) = 0,$$

which is equivalent to (4.21).



## Chapter 5

# Waves on a Sloping Beach; Shallow Water Theory

IN THE LAST chapter we considered flow over a horizontal level surface. In the case of a non-uniform bottom, we will get an additional term in the horizontal momentum equation due to the force acting on the bottom surface. 57

### 5.1 Shallow water equations

We choose a coordinate system  $x, y$  such that  $y = -h_0(x)$  denotes the bottom and  $y = \eta(x, t)$  the water surface. Hence the total depth  $h(x, t)$  is

$$h(x, t) = h_0(x) + \eta(x, t).$$

The equation of conservation of mass is

$$(5.1) \quad \frac{d}{dt} \int_{x_2}^{x_1} h(x, t) dx + [uh]_{x_2}^{x_1} = 0$$

as before, and if  $u$  and  $h$  are continuously differentiable, then

$$(5.1)' \quad h_t + (uh)_x = 0.$$

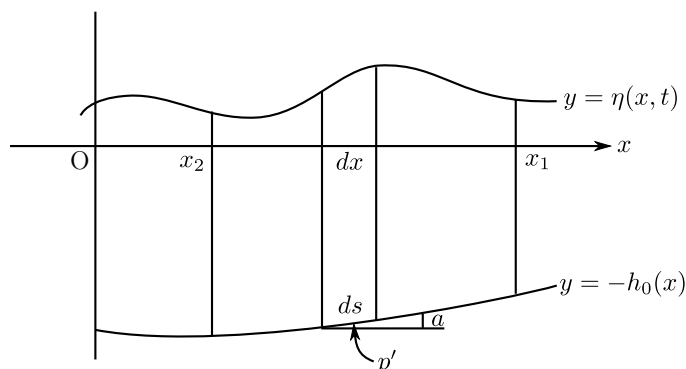

Figure 5.1:

58 Let us now consider the momentum balance in the  $x$ -direction. Let  $p'$  be the excess pressure as before. When the bottom is not horizontal, the contribution of  $p'$  from the bottom surface will have a non-zero horizontal component. Let us consider a thin section of thickness  $dx$  and let  $ds$  be the line element along the bottom  $y = -h_0(x)$ . Let  $\alpha$  be the inclination of  $ds$  to the  $x$ -axis. Then

$$ds = \frac{dx}{\cos \alpha}.$$

Hence the momentum balance in the horizontal direction is

$$(5.2) \quad \frac{d}{dt} \int_{x_2}^{x_1} hu \, dx + \left[ hu^2 + \frac{1}{2} gh^2 \right]_{x_2}^{x_1} = - \int_{x_2}^{x_1} \left( p' \frac{dx}{\cos \alpha} \right) \sin \alpha$$

In the shallow water theory we have  $p' = g(\eta - y)$ . At  $y = -h_0$ ,  $p' = g(\eta + h_0) = gh$ . Therefore (5.2) becomes

$$(5.3) \quad \frac{d}{dt} \int_{x_2}^{x_1} hu \, dx + \left[ hu^2 + \frac{1}{2} gh^2 \right]_{x_2}^{x_1} = \int_{x_2}^{x_1} gh \frac{dh_0}{dx} dx,$$

since  $\frac{dh_0}{dx} = \tan \alpha$ . If all the quantities are smooth, in the limit  $x_2 \rightarrow x_1$ , we obtain

$$(5.4) \quad (hu)_t + \left( hu^2 + \frac{1}{2} gh^2 \right)_x = gh \frac{dh_0}{dx}$$

When there are discontinuities, the shock condition derived from (5.3) is

$$-U[hu] + \left[ hu^2 + \frac{1}{2} gh^2 \right] = 0,$$

since the right hand side of (5.3) becomes zero in the limit  $x_2 \rightarrow x_1$ . Thus, the shock conditions are unaffected by the extra term  $gh \frac{dh_0}{dx}$  due to the non-uniform bottom.

Using the mass conservation equation (5.1)' the momentum equation (5.4) can be written as

$$u_t + uu_x + g\eta_x = 0.$$

Hence the system of equations for the flow of shallow water over a non-uniform bottom is

$$(5.5) \quad \left. \begin{aligned} h_t + uh_x + hu_x &= 0, \\ u_t + uu_x + g\eta_x &= 0, \\ h &= h_0 + \eta. \end{aligned} \right\}$$

## 5.2 Linearized equations

We assume that the disturbances are small of order  $\epsilon \ll 1$  i.e.  $\frac{\eta}{h_0} = 0(\epsilon)$  and  $\frac{u}{\sqrt{gh_0}} = o(\epsilon)$ . We also assume that the derivative are also of the same order.

Since  $h = \eta(x, t) + h_0(x)$ , equations (5.5) can be written down as

$$(5.6) \quad \eta_t + uh'_0 + h_0u_x + u\eta_x + \eta u_x = 0$$

$$(5.7) \quad u_t + uu_x + g\eta_x = 0.$$

The first three terms of (5.6) are of order  $0(\epsilon)$  whereas the last two terms are of order  $0(\epsilon^2)$ . In the equation (5.7)  $uu_x = 0(\epsilon^2)$  and the other terms are of order  $\epsilon$ . Hence to a first order approximation we have

$$(5.8) \quad \left. \begin{aligned} \eta_t + h_0u_x + h'_0\eta &= 0, \\ u_t + g\eta_x &= 0. \end{aligned} \right\}$$

Equations (5.8) are the linearized versions of equations (5.5). Differentiating the first equation of (5.8) partially w.r.t.  $t$  and using the second equation, we obtain

$$(5.9) \quad \eta_{tt} = gh_0\eta_{xx} + gh'_0\eta_x.$$

This is the wave equation with an additional term. If  $h_0$  were constant then

$$\eta_{tt} = gh_0\eta_{xx}$$

and the general solution of this is

$$\eta = f_1(x - \sqrt{gh_0}t) + f_2(x + \sqrt{gh_0}t).$$

The velocity of propagation is  $\sqrt{gh_0}$ .

### 5.3 Linear theory for waves on a sloping beach

We now consider a sloping beach with inclination  $\beta$  to the horizontal. We assume  $\beta$  to be small so that linearized shallow water theory can be applied.

However there will be some questions about validity to be considered later. These are

- (i) The question of using the shallow water theory as  $x \rightarrow \infty$ , when the water becomes deep.
- (ii) The question of the assumption  $\eta/h_0 \ll 1$  near  $x = 0$  where  $h_0 \rightarrow 0$ .

We have to solve equation (5.9) with  $h_0 = x \tan \beta$  and we take  $h_0 \simeq \beta x$  since  $\beta$  is very small. Hence the equation can be written as

$$(5.10) \quad \eta_{tt} = g\beta x\eta_{xx} + g\beta\eta_x.$$

61 Let  $\eta = N(x)e^{-i\omega t}$  be a solution of equation (5.10). Then we obtain an ordinary differential equation for  $N$  as follows:

$$(5.11) \quad N'' + \frac{1}{x}N' + \frac{\omega^2}{g\beta} \frac{1}{x}N = 0.$$

This is to be solved in  $0 < x < \infty$ .

The point  $x = 0$  is a regular point of equation (5.11), and  $x = \infty$  is an irregular point. This suggests a transformation to Bessel's equation or some other confluent hypergeometric equation. In fact the transformation

$$x = \frac{g\beta}{\omega^2} \frac{X^2}{4}$$

converts it into the Bessel equation of order zero.

$$(5.12) \quad \frac{d^2 N}{dX^2} + \frac{l}{X} \frac{dN}{dX} + N = 0.$$

The Bessel functions  $J_0(X)$ ,  $Y_0(X)$  are two linearly independent solutions of the equation (5.12). Hence a general solution of (5.11) is

$$N = AJ_0\left(2\omega\sqrt{\frac{x}{g\beta}}\right) - iBY_0\left(2\omega\sqrt{\frac{x}{g\beta}}\right),$$

where  $A$  and  $B$  are constants. Since the power series for  $J_0(X)$  contains only even powers of  $X$ ,  $J_0\left(2\omega\sqrt{\frac{x}{g\beta}}\right)$  is an integer power series in  $x$  and is regular at the beach  $x = 0$ . We note that  $Y_0$  has a logarithmic singularity at  $x = 0$ .

The complete solution of (5.10) is

$$\eta(x, t) = \left\{ AJ_0\left(2\omega\sqrt{\frac{x}{g\beta}}\right) - iBY_0\left(2\omega\sqrt{\frac{x}{g\beta}}\right) \right\} e^{-i\omega t}.$$

As  $x \rightarrow \infty$  the asymptotic formula for  $\eta$  is

$$(5.13) \quad \eta \sim \frac{1}{\sqrt{\pi}} \left(\frac{g\beta}{\omega^2 x}\right)^{1/4} \frac{A+B}{2} \exp\left(-i2\omega\sqrt{\frac{x}{g\beta}} - i\omega t + \frac{\pi i}{4}\right) + \frac{A-B}{2} \exp\left(i2\omega\sqrt{\frac{x}{g\beta}} - i\omega t - \frac{\pi i}{4}\right).$$

The first term in the bracket corresponds to an incoming wave and the second one to an outgoing wave. In a uniform medium an outgoing periodic wave is given by

$$ae^{ikx - i\omega t},$$

where  $\kappa, \omega, a$  are the wave number, frequency and amplitude respectively. The terms in (5.13) are generalizations to the form

$$a(x, t)e^{i\theta(x, t)}.$$

A generalized wave number and frequency can be defined in terms of the phase function  $\theta(x, t)$  by

$$(5.14) \quad \kappa(x, t) = \theta_x, \quad \nu(x, t) = -\theta_t;$$

the generalized phase velocity is

$$(5.15) \quad c(x, t) = \frac{\nu}{\kappa} = -\frac{\theta_t}{\theta_x}.$$

The function  $a(x, t)$  is the amplitude.

In our particular case the outgoing wave has

$$\theta(x, t) = 2\omega \sqrt{\frac{x}{g\beta}} - \omega t - \frac{\pi}{4}.$$

Hence the wave number, frequency and phase velocity are

$$\begin{aligned} \kappa(x, t) &= \theta_x = \frac{\omega}{\sqrt{g\beta x}}, \\ \nu(x, t) &= -\theta_t = \omega, \\ c(x, t) &= \sqrt{g\beta x}. \end{aligned}$$

63 We note that the waves get shorter as  $x \rightarrow 0$ , and that  $c = \sqrt{gh_0(x)}$  is the generalization of the result for constant depth. The incoming wave is similar with the opposite sign of propagation.

**Behavior as  $x \rightarrow \infty$**

We note that the amplitude  $a$  varies proportional to  $x^{-1/4}$ . As  $x \rightarrow \infty, a \rightarrow 0$ . This means that, within shallow water, we cannot pose the natural problem of a prescribed incoming wave at infinity with a given

**nonzero** amplitude. This is due to the failure of the shallow water assumptions at  $\infty$ , one of the questions noted at the beginning of this section. It is found from the full theory in Chapter 7, (for the solution corresponding to  $J_0$ ) that the ratio of amplitude at infinity  $a_\infty$  to amplitude at shoreline  $a_0$  is in fact  $(2\beta/\pi)^{1/2}$ . Therefore,  $a_\infty/a_0 \rightarrow 0$  as  $\beta \rightarrow 0$ , and the  $x^{-1/4}$  behavior is the shallow water theory's somewhat inadequate attempt to cope with this. However, the full solution does show that the shallow water theory is a good approximation near the shore. And it is valuable there since, for example, the corresponding nonlinear solution can be found in the shallow water theory (see the next section) but not in the full theory.

#### Behavior as $x \rightarrow 0$ and breaking .

We see from (5.13) that the ratio of  $B$  to  $A$ , which controls the amount of  $J_0$  and  $Y_0$  in the solution, also determines the proportion of incoming wave that is reflected back to infinity.

For  $B = 0$ , we have perfect reflection with

64

$$(5.16) \quad \eta = AJ_0 \left( 2\omega \frac{\sqrt{x}}{g\beta} \right) e^{-i\omega t}$$

and the solution is bounded and regular at the shoreline  $x = 0$ .

In the other extreme,  $A = B$ , there is no reflection, we have a purely incoming wave

$$(5.17) \quad \eta = A (J_0 - iY_0) e^{-i\omega t},$$

but it is now singular at the shoreline. The interpretation of the singularity is that it is the linear theory's crude attempt to represent the breaking of waves and the associated loss of energy. As  $B$  increases, more energy goes into the singularity (breaking) and less is reflected.

Although breaking is the most obvious phenomenon we observe at the seashore, a number of long wave phenomena (long swells, edge waves, tsunamis) are in the range where breaking does not occur so that the  $J_0$  solution ( $B = 0$ ) with perfect reflection is relevant. This is fortunate since practical use of the  $Y_0$  solution would be limited, although the situation is mathematically interesting.

The singular solution is related also to the second question noted at the beginning of this section: The breakdown of the linearizing assumption  $\eta/h_0 \ll 1$  as  $h_0 \rightarrow 0$  at the shoreline. On this we can say that the nonlinear solution corresponding to  $J_0$  can be found without this assumption (next section), and it endorses the linear approximation. The  $Y_0$  solution with its crucial ties to complicated nonlinear breaking is clearly a different matter.

### The eigenvalue problem and expansion theorem .

One further aspect of the  $Y_0$  solution is certainly intriguing mathematically. The eigenvalue problem (5.11) with  $\omega^2/g\beta$  as eigenparameter is of "limit circle" type at  $x = 0$ . This is identified by the fact that **both** solutions are square integrable there and it has important ramifications in the general theory of eigenfunction expansions. The main one is that various choices of linear combinations of  $J_0$  and  $Y_0$  each lead to a satisfactory eigenfunction expansion to represent a given square integrable function (as required, say, in solving the initial value problem). In our context this is interpreted as an arbitrary choice of the degree of breaking, within this theory. The natural choice would then appear to be an expansion theorem

$$(5.18) \quad f(x) = \int_0^{\infty} A(\omega) \left\{ J_0 \left( 2\omega \sqrt{\frac{x}{g\beta}} \right) - im Y_0 \left( 2\omega \sqrt{\frac{x}{g\beta}} \right) \right\} d\omega$$

where **we must give**  $m$  in the range  $0 \leq m \leq 1$  to indicate our estimate of the relative amount of breaking. With the choice  $m = 0$  this is the usual Fourier-Bessel expansion, and is certainly one valid possibility. When  $m \neq 0$ , the result obtained from the usual general theory (see Titchmarsh [2], p. 78) is not quite (5.18). The  $Y_0$  has to be replaced by

$$(5.19) \quad Y_0 \left( 2\omega \sqrt{\frac{x}{g\beta}} \right) - \frac{2}{\pi} J_0 \left( 2\omega \sqrt{\frac{x}{g\beta}} \right) \log \omega.$$

66

It seems hard to find a "natural" physical interpretation for this modification. Moreover, one may still ask whether the unmodified form



(5.18) is in fact a correct possible choice. A further question that arises, since we expect different amounts of breaking for different frequencies, is whether there is an expansion theorem for reasonable choices of **functions**  $m(\omega)$  in (5.18).

It might be remarked that these points are particularly interesting because in most applications where the “limit circle” case arises, only a bounded solution makes physical sense and the one parameter arbitrariness is not in fact used in any significant way. The niceties of the mathematical discussion are not displayed.

#### Tidal estuary problem .

In a channel where the breadth  $b(x)$  varies, as well as the depth  $h_0(x)$ , the shallow water equations are modified to

$$\begin{aligned} \frac{\partial}{\partial t} \{(h_0 + \eta) b\} + \frac{\partial}{\partial x} \{(h_0 + \eta) ub\} &= 0, \\ \frac{\partial u}{\partial t} + u \frac{\partial u}{\partial x} + g \frac{\partial \eta}{\partial x} &= 0. \end{aligned}$$

For the case  $h_0(x) = \beta x$ ,  $b(x) = \alpha x$  the linearized equation for  $\eta$  can again be solved in Bessel functions. G.I. Taylor used this solution to study the large tidal variations in the Bristol channel. In this application to extremely long waves, breaking is not an issue and only the  $J_n$  solution is accepted.

## 5.4 Nonlinear waves on a sloping beach

67

In Section 5.3 we considered the linear approximation of the equations for waves on a sloping beach. Carrier and Greenspan [4] in 1958 gave an exact solution of the nonlinear equations using a modified type of hodograph transformation applied to characteristic variables. We recall that the governing equations are

$$\begin{aligned} h_t + uh_x + hu_x &= 0, \\ u_t + uu_x + gh_x - g\beta &= 0, \end{aligned}$$

where  $h = \beta x + \eta(x, t)$ .

Introducing the variable  $c = \sqrt{gh}$ , which we know to be significant, the above equations become

$$(5.20) \quad \left. \begin{aligned} 2c_t + 2uc_x + cu_x &= 0, \\ u_t + uu_x + 2cc_x - g\beta &= 0. \end{aligned} \right\}$$

Due to the presence of the term  $g\beta$ , the straight forward hodograph transformation  $(u, c) \rightarrow (x, t)$  will not simplify the equations, since this time the Jacobian  $g$  would not cancel through. However, Carrier and Greenspan introduced new variables suggested by the characteristic forms and applied a hodograph transformation to these.

The characteristic forms of the equations (5.20) are

$$\begin{aligned} (u + 2c)_t + (u + c)(u + 2c)_x - g\beta &= 0, \\ (u - 2c)_t + (u - c)(u - 2c)_x - g\beta &= 0. \end{aligned}$$

68 These can be written as

$$\begin{aligned} (u + 2c - g\beta t)_t + (u + c)(u + 2c - g\beta t)_x &= 0, \\ (u - 2c - g\beta t)_t + (u - c)(u - 2c - g\beta t)_x &= 0. \end{aligned}$$

The  $\mathcal{C}_+$  and  $\mathcal{C}_-$  characteristic curves are defined by

$$(5.21) \quad \left. \begin{aligned} \mathcal{C}_+ : \frac{dx}{dt} = u + c, \quad u + 2c - g\beta t &= \text{constant}, \\ \mathcal{C}_- : \frac{dx}{dt} = u - c, \quad u - 2c - g\beta t &= \text{constant}. \end{aligned} \right\}$$

We define the characteristic variables  $p, q$  by

$$(5.22) \quad p = u + 2c - g\beta t,$$

$$(5.23) \quad q = u - 2c - g\beta t.$$

Then equations (5.21) can be written

$$\begin{aligned} x_q &= (u + c)t_q, \\ x_p &= (u - c)t_p, \end{aligned}$$

which introduces the hodograph transformation  $(p, q) \rightarrow (x, t)$ . Solving (5.22), (5.23) for  $u, c$  and inserting them in the above equations we obtain

$$(5.24) \quad \left. \begin{aligned} x_q &= \left( \frac{3p+q}{4} + g\beta t \right) t_q, \\ x_p &= \left( \frac{p+3q}{4} + g\beta t \right) t_p. \end{aligned} \right\}$$

Equations (5.24) are still nonlinear, but by good fortune the nonlinear terms are in the form  $(\frac{1}{2}g\beta t^2)_q, (\frac{1}{2}g\beta t^2)_p$  so that when we take cross derivatives and subtract to obtain an equation for  $t$ , these terms cancel each other. This was the remarkable fact observed by Carrier and Greenspan. Differentiating the first equation in (5.24) partially with respect to  $p$  and the second equation with respect to  $q$  and subtracting we obtain 69

$$(5.25) \quad 2(p-q)t_{pq} + 3(t_q - t_p) = 0.$$

Equation (5.25) is a **linear** equation which can be solved by standard methods.

This is the main step, but further transformations can be used to convert (5.25) into the cylindrical wave equation whose solutions are already well documented. First, by the transformation

$$(5.26) \quad \begin{aligned} \sigma &= p - q, \\ \lambda &= -(p + q), \end{aligned}$$

equation (5.25) becomes

$$(5.27) \quad t_{\lambda\lambda} = t_{\sigma\sigma} + \frac{3}{\sigma}t_\sigma.$$

This can be further simplified by introducing the transformation

$$(5.28) \quad g\beta t = \frac{\lambda}{2} - \frac{\phi_\sigma}{\sigma};$$

the term  $-\frac{\phi_\sigma}{\sigma}$  is for transforming (5.27) into the cylindrical wave equation and the term  $\frac{\lambda}{2}$  is included to give a simple final form for  $u$ . Thus we obtain cylindrical wave equation

$$(5.29) \quad \phi_{\lambda\lambda} = \phi_{\sigma\sigma} + \frac{1}{\sigma}\phi_\sigma$$

Equations (5.22), (5.23) give  $u, c$  in terms of  $p, q$ . From the transformation (5.26) we obtain  $p, q$  in terms of  $\sigma, \lambda$ . These together with equation (5.28) lead to

$$(5.30) \quad c = \frac{\sigma}{4}$$

$$(5.31) \quad u = -\frac{\phi_\sigma}{\sigma},$$

$$(5.32) \quad g\beta t = \frac{\lambda}{2} - \frac{\phi_\sigma}{\sigma}.$$

70 It can be shown from (5.24), with a use of (5.29), that

$$(g\beta x)_\sigma = \left( -\frac{1}{4}\phi_\lambda + \frac{1}{2}\frac{\phi_\sigma^2}{\sigma^2} + \frac{\sigma^2}{16} \right)_\sigma,$$

$$(g\beta x)_\lambda = \left( -\frac{1}{4}\phi_\lambda + \frac{1}{2}\frac{\phi_\sigma^2}{\sigma^2} \right)_\lambda.$$

From these we obtain

$$(5.33) \quad g\beta x = -\frac{1}{4}\phi_\lambda + \frac{1}{2}\frac{\phi_\sigma^2}{\sigma^2} + \frac{\sigma^2}{16}.$$

The final set of transformations (5.30)-(5.33) is sufficiently involved that it seems inconceivable that anyone would discover them directly. One can note that

$$u - g\beta t = -\frac{\lambda}{2} \quad \text{and} \quad \frac{1}{2}u^2 + c^2 - g\beta x = +\frac{1}{4}\phi_\lambda$$

take simple forms and these combinations appear in two alternative ways of absorbing  $g\beta$  in conservation forms for the second of (5.20), i.e.

$$(u - g\beta t)_t + \left( \frac{1}{2}u^2 + c^2 \right)_x = 0,$$

$$u_t + \left( \frac{1}{2}u^2 + c^2 - g\beta x \right)_x = 0.$$

But this comment does not appear to lead any further.

Almost equally important as the linearity of (5.29) is the fact that the moving shoreline  $c = 0$  is now fixed at  $\sigma = 0$  in the new independent variables. We can now work in a fixed domain.

The simplest separable solution of (5.29) is

$$(5.34) \quad \phi = N(\sigma) \cos \alpha \lambda,$$

where  $\alpha$  is an arbitrary separation constant. The equation for  $N(\sigma)$  is then the Bessel equation of order zero.

$$(5.35) \quad N'' + \frac{1}{\sigma}N' + \alpha^2 N = 0.$$

The solution bounded at the shoreline  $\sigma = 0$  is

71

$$N = AJ_0(\alpha\sigma),$$

where  $A$  is a constant. Hence

$$(5.36) \quad \phi = AJ_0(\alpha\sigma) \cos \alpha \lambda.$$

Equation (5.36) together with the above transformations and relations give an exact solution for the non linear equation (5.20).

### Linear approximation .

It will be useful to note how the linearized approximation is obtained from (5.36). In the linear theory  $u$  is small which implies  $\phi$  is small. Hence to a first order approximation we obtain from (5.32), (5.33) that

$$(5.37) \quad \begin{aligned} g\beta t &\simeq \frac{\lambda}{2}, \\ g\beta x &\simeq \frac{\sigma^2}{16}. \end{aligned}$$

Thus

$$\phi \simeq AJ_0 \left( 4\alpha \sqrt{g\beta x} \right) \cos(2\alpha g\beta t).$$

Taking  $\alpha = \frac{\omega}{2g\beta}$  we obtain

$$\phi \simeq AJ_0\left(2\omega\sqrt{\frac{x}{g\beta}}\right)\cos\omega t$$

which is in agreement with our result obtained in section 5.3. To relate  $\phi$  to the particle velocity  $u$  and elevation  $\eta$ , we first note that

$$\begin{aligned} u &= -\frac{\phi_\sigma}{\sigma} = -\alpha^2 A \frac{J'_0(\alpha\sigma)}{\alpha\sigma} \cos\alpha\lambda \\ &\simeq \frac{2\omega a_0}{\beta} \frac{J'_0\left(2\omega\sqrt{\frac{x}{g\beta}}\right)}{2\omega\sqrt{\frac{x}{g\beta}}} \cos\omega t, \end{aligned}$$

72 where

$$(5.38) \quad a_0 = \frac{\beta}{2\omega} \alpha^2 A = \frac{\omega}{8g\beta^2} A.$$

Then rather than trying to improve on the approximation for  $\sigma$  and hence  $c$  to find  $\eta$ , we rather note that the above linearized approximation for  $u$  goes along in linear theory with

$$(5.39) \quad \eta = -a_0 J_0\left(2\omega\sqrt{\frac{x}{g\beta}}\right) \sin\omega t.$$

These approximations provide a rough way to interpret the variables in the nonlinear form (5.36). In particular we see it as the nonlinear counterpart of the wave with perfect reflection at the beach.

**Run-up.** Perhaps the most important quantity among the results is the range of  $x$  at the shoreline  $\sigma = 0$ , since this provides the amplitude of the run-up.

If  $x = F(\lambda, \sigma)$  then the range of  $x$  at  $\sigma = 0$  is  $[\min_{\lambda} F(\lambda, 0), \max_{\lambda} F(\lambda, 0)]$ .

Using (5.33), (5.36) and the fact that  $\lim_{z \rightarrow 0} \frac{J'_0(z)}{z} = -\frac{1}{2}$  we obtain:

$$\text{at the shore } \sigma = 0, \quad g\beta x = \frac{1}{4} \alpha A \sin\alpha\lambda + \frac{1}{8} \alpha^4 A^2 \cos^2\alpha\lambda.$$

At maximum or minimum run-up,  $u = -\phi_\sigma/\sigma = 0$ . Therefore, from (5.36),

$$\cos \alpha\lambda = 0, \quad \text{and hence} \quad \sin \alpha\lambda = \pm 1.$$

Therefore at the maximum run up:  $g\beta x = \frac{1}{4}\alpha A$ , at the minimum run up:  $g\beta x = -\frac{1}{4}\alpha A$ . Hence the range of  $x$  is

$$-\frac{\alpha A}{4g\beta} \leq x \leq \frac{\alpha A}{4g\beta}.$$

73

If  $a_0$  is the vertical amplitude, we have

$$(5.40) \quad a_0 = \frac{\alpha A}{4g}.$$

This agrees with (5.38) when the linearized relation  $\alpha = \omega/2g\beta$  is used. The latter will not be quite accurate in the nonlinear theory for the relation of  $\alpha$  to the frequency  $\omega$ , but it is probably a good enough approximation; the exact relation could, of course, be calculated.

**Breaking condition.** In finding a solution for equations (5.20) we made use of many transformations and got a solution which is single valued, bounded and smooth in terms of the variables  $\lambda, \sigma$ . When the Jacobian of the transformation  $(\lambda, \sigma) \rightarrow (x, t)$  becomes zero the solution in the  $xt$ -plane will be multivalued i.e. breaking will occur. We will find the condition for breaking to occur. By (5.24) and (5.26),

$$\begin{aligned} g &= x_\lambda t_\sigma - x_\sigma t_\lambda \\ &= (ut_\lambda + ct_\sigma)t_\sigma - (ct_\lambda + ut_\sigma)t_\lambda \\ &= c(t_\sigma^2 - t_\lambda^2) \end{aligned}$$

Differentiating (5.32) partially with respect to  $\sigma$  and  $\lambda$  and using (5.36), we obtain

$$\begin{aligned} g\beta t_\sigma &= \frac{A\alpha^3}{z} \left( J_0 + \frac{2}{z} J'_0 \right) \cos \alpha\lambda, \\ g\beta t_\lambda &= \frac{1}{2} + \frac{A\alpha^3}{z} J'_0 \sin \alpha\lambda, \end{aligned}$$

where  $z = \alpha\sigma$ . Using the relations

$$J'_0 = -J_1; J_0 + \frac{2}{z}J'_0 = -J_2,$$

we obtain

$$(5.41) \quad g\beta(t_\lambda - t_\sigma) = \frac{1}{2} - A\alpha^3 \left( \frac{J_1 \sin \alpha\lambda - J_2 \cos \alpha\lambda}{z} \right),$$

$$(5.42) \quad g\beta(t_\lambda + t_\sigma) = \frac{1}{2} - A\alpha^3 \left( \frac{J_1 \sin \alpha\lambda + J_2 \cos \alpha\lambda}{z} \right).$$

Now

$$\frac{J_1 \sin \alpha\lambda \pm J_2 \cos \alpha\lambda}{z} = \frac{J_1^2 + J_2^2}{z^2} \sin(\alpha\lambda \pm \eta);$$

where  $\eta = \tan^{-1}(\frac{J_2}{J_1})$ . Hence, the maximum values of these expressions are

$$\frac{J_1^2 + J_2^2}{z^2}.$$

It can be shown that

$$\frac{d}{dz} \left( \frac{J_1^2 + J_2^2}{z^2} \right) = -\frac{6}{z^3} J_2^2 \leq 0 \quad \text{for } z > 0.$$

Hence for positive  $z$ ,  $\frac{J_1^2 + J_2^2}{z^2}$  is a decreasing function and its maximum value is attained at  $z = 0$ , where it is equal to  $1/2$ . Therefore the factors in (5.41), (5.42) first vanish when  $A\alpha^3 = 1$ , and breaking first occurs at the shoreline.

If we again use the approximate relation  $\alpha = \frac{\omega}{2g\beta}$ , together with (5.40) a necessary and sufficient condition for breaking to occur is

$$(5.43) \quad \frac{\omega^2 a_0}{g\beta^2} \geq 1.$$

This is a very fruitful result obtained from the nonlinear theory. Breaking is obviously a complicated phenomenon with wide variations



in type and conditions. But (5.43) gives a valuable result on the significant combination of parameters. From observations also it is found that the quantity  $P = \frac{\omega^2 a_0}{g\beta^2}$  plays an important role. Galvin's experiments and observations [5] group breaking phenomena into different ranges of  $P$ . He distinguishes the ranges (although with some overlap).

$P$	Type
$\leq 0.045$	Surging; no breaking
0.045 – 0.81	Collapsing; Fig. 5.2
0.28 – 19	Plunging; Fig. 5.3
14 – 64	Spilling; Fig. 5.4

Munk and Wimbush [6] give further supporting evidence and arguments. The criterion (5.43) is thought to correspond very roughly to the plunging regime.

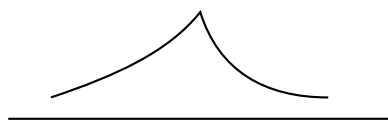

Figure 5.2:



Figure 5.3:



Figure 5.4:

Carrier and Greenspan [4] give other solutions and include the analysis for solving the general initial value problem.

## 5.5 Bore on beach

When breaking occurs, a discontinuous “bore”, corresponding to the shocks discussed earlier would be fitted in. The appropriate jump conditions were noted in Section 4.1. This has not been carried through in the Carrier-Greenspan solutions. However the simpler problem of what happens when a bore initially moving with constant speed and strength in an offshore region of constant depth impinges on a sloping beach has been studied by approximate and numerical methods. Reference may be made to the original papers [7] and [8] and recent additions in [9].

## 5.6 Edge waves

In the previous section we have considered only normal incidence with dependence only on distance  $x$  normal to the shore. We now turn to phenomena that include longshore dependence. If  $x_1$  is normal to and  $x_2$  is along the shore, the linearized equation for the surface elevation  $\eta(x_1, x_2, t)$  is modified from (5.10) to

$$(5.44) \quad \eta_{tt} = g\beta x_1 (\eta_{x_1 x_1} + \eta_{x_2 x_2}) + g\beta \eta_{x_1}.$$

77 The modification is slight and we do not give the derivation. We use separation of variables and let

$$(5.45) \quad \eta = N(x_1) e^{\pm i k x_2 \pm i \omega t}.$$

Then  $N(x_1)$  satisfies

$$(5.46) \quad N'' + \frac{1}{x_1} N' + \left( \frac{\omega^2}{g\beta x_1} - k^2 \right) N = 0.$$

The interval of interest is  $0 < x_1 < \infty$ . The origin  $x_1 = 0$  is a regular singular point; one solution is analytic and the other has a logarithmic

singularity. At  $\infty$ , the equation is roughly

$$(5.47) \quad N'' - k^2 N \simeq 0,$$

with solutions

$$(5.48) \quad N \simeq e^{-kx_1}, e^{kx_1}.$$

In this case only the solutions bounded at both  $x_1 = 0$  and appear to be of interest. We shall see that the solutions represent waves running along the beach, and no-one seems to have interpreted the logarithmic solution in any sense such as breaking. So we choose the analytic solution near  $x_1 = 0$ . Then, in general, this solution will be a linear combination of both  $e^{-kx_1}$  and  $e^{+kx_1}$  at  $\infty$ . For an acceptable physical solution the term in  $e^{kx_1}$  should be absent. This is possible only for special values of  $\omega^2/g\beta$ . We have a singular eigenvalue problem. If we set

$$(5.49) \quad N = e^{-kx_1} F(X), \quad X = 2kx_1, \quad k > 0,$$

it becomes a standard one. We have

$$(5.50) \quad XF_{XX} + (1 - X)F_X + \frac{1}{2} \left( \frac{\omega^2}{g\beta k} - 1 \right) F = 0,$$

and the required solutions are Laguerre polynomials

$$L_n(X) = e^X \frac{d^n}{dX^n} (X^n e^{-X}),$$

with

78

$$(5.51) \quad \omega^2 = gk(2n + 1)\beta, \quad n = \text{positive integer}$$

The solution for  $N(x_1)$  is

$$(5.52) \quad N(x_1) = e^{-kx_1} L_n(2kx_1).$$

The final solutions for  $\eta$  are

$$(5.53) \quad \eta = e^{-|k|x_1} L_n(2|k|x_1) e^{\pm ikx_2 \pm i\omega t},$$

where  $|k|$  is appropriate if negative values of  $k$  are used.

These solutions all decay away from the shoreline and have crests perpendicular to the shoreline. For this reason they are known as ‘edge waves’. The lowest mode  $n = 0$  has

$$N(x_1) = e^{-kx_1}, \quad \omega^2 = gk\beta, \quad k > 0,$$

and one might take for example

$$(5.54) \quad \eta = e^{-kx_1} \cos(kx_2 - \omega t).$$

This corresponds to a solution first found by Stokes. It is interesting to note how the different terms in (5.54) are balanced by this solution. One might note the propagation speed is  $\sqrt{g\beta x_1}$  and expect the waves to swing round to the beach due to the increase of speed with  $x_1$ . The final result avoids this and we see from (5.54) that the balance is

$$(5.55) \quad \eta_{x_1 x_1} + \eta_{x_2 x_2} = 0, \quad \eta_{tt} = g\beta \eta_{x_1}$$

The propagation speed argument applies directly when  $\eta_{tt}$  balances the second derivatives in  $(x_1, x_2)$ ; the balance in (5.55) avoids this.

79 The equation is hyperbolic but these particular solutions avoid the hyperbolic character and appear as ‘dispersive waves’ with dispersion relations given in (5.51). (See [1] Chapter 1 for a discussion of the distinctions, and Chapter 11 for the main properties of dispersive waves).

We also note there is no possibility of an oblique wave at  $\infty$ . This would require

$$\eta \sim e^{\pm i\ell x_1 \pm ikx_2 \pm i\omega t}$$

with real  $\ell$  and  $k$ . We have only the wave of normal incidence found in Section 5.5,

$$(5.56) \quad \eta = J_0 \left( 2\omega \sqrt{\frac{x}{g\beta}} \right) e^{\pm i\omega t},$$

or the edge waves travelling along the beach. As noted earlier, (5.56) does not have a finite nonzero amplitude at  $\infty$ , but it does at least represent a normal wave. For the oblique case there is not even a corresponding solution. This again is a breakdown of the shallow water assumption in deep water. We can interpret the result roughly by remarking

that oblique deep water waves would in reality swing around towards the shore when they feel the depth decrease. They do this completely, and achieve normal incidence as in (5.56), by the time the shallow water theory applies. In the linear theory, edge waves are not stimulated directly by incoming waves at infinity. We check these explanations from the full linear theory in Chapter 7.

## 5.7 Initial value problem and completeness

80

Conversely if we turn to the case of an initial disturbance of finite extent, we need only the edge waves. The solutions (5.52) for integers  $n \geq 0$  form a complete set, and any square integrable function of  $x_1$  can be represented as an infinite series. Combined with a Fourier integral with respect to  $x_2$  in (5.53), we can represent any square integrable function of  $(x_1, x_2)$ . For example, the solution of the initial value problem

$$\eta = \eta_0(x_1, x_2), \quad \eta_t = 0, \quad \text{at } t = 0$$

would be

$$(5.57) \quad \eta = \sum_{m=0}^{\infty} \int_{-\infty}^{\infty} A_m(k) e^{-|k|x_1} L_m(2|k|x_1) e^{ikx_2} \cos t \sqrt{g(2m+1)|k|} dk,$$

where, using the two inversion formulas,

(5.58)

$$A_m(k) = \frac{1}{\pi} \int_0^{\infty} \int_{-\infty}^{\infty} \eta_0(\xi_1, \xi_2) e^{-|k|\xi_1} L_m(2|k|\xi_1) \frac{|k|}{(m!)^2} e^{-ik\xi_2} d\xi_1 d\xi_2.$$

A term proportional to (5.56) is not required since the Laguerre polynomials are already complete. Of course, one would expect the solution for an initial disturbance that is very long in the  $x_2$  direction to be represented closely by a superposition of the normal incidence solutions (5.56). To resolve the apparent difference in form, we consider the case

$$\eta_0(x_1, x_2) = f(x_1)g(x_2);$$

then

$$A_m(k) = \int_0^{\infty} f(\xi_1) e^{-|k|\xi_1} L_m(2|k|\xi_1) \frac{2|k|}{(m!)^2} d\xi_1 \times \frac{1}{2\pi} \int_{-\infty}^{\infty} g(\xi_2) e^{-ik\xi_2} d\xi_2.$$

81

As  $g \rightarrow 1$ , the second factor in  $A_m(k)$  becomes the Dirac delta function  $\delta(k)$ . Hence, after substitution in (5.57) we have

$$\eta = \lim_{k \rightarrow 0} \left\{ \sum_{m=0}^{\infty} \left( \int_0^{\infty} \frac{f(\xi_1) L_m(2|k|\xi_1) d\xi_1}{m!} \frac{L_m(2|k|x_1)}{m!} \cos \sqrt{g|k|(2m+1)t} \cdot 2|k| \right) \right\}.$$

Because of the factor  $|k|$ , the contribution comes from the addition of many small terms for large  $m$ . As  $m \rightarrow \infty$ ,  $|k|m$  finite,

$$(5.59) \quad \frac{L_m(2|k|x_1)}{m!} \sim J_0(2\sqrt{2m|k|x_1}).$$

Using this and introducing

$$-\frac{\omega_m^2}{g\beta} = 2|k|m, \quad 2|k| - \Delta \left( \frac{\omega_m^2}{g\beta} \right),$$

we have

$$\eta \sim \sum_{m=0}^{\infty} \left\{ \int_0^{\infty} f(\xi_1) J_0 \left( 2\omega_m \sqrt{\frac{\xi_1}{g\beta}} \right) d\xi_1 \right\} \times J_0 \left( 2\omega_m \sqrt{\frac{x_1}{g\beta}} \right) \cos \omega_m t \cdot \Delta \left( \frac{\omega_m^2}{g\beta} \right).$$

This is the Riemann sum for

$$\eta = \int_0^{\infty} \left\{ \int_0^{\infty} f(\xi_1) J_0 \left( 2\omega \sqrt{\frac{\xi_1}{g\beta}} \right) d\xi_1 \right\} J_0 \left( 2\omega \sqrt{\frac{x_1}{g\beta}} \right) \cos \omega t \Delta \left( \frac{\omega^2}{g\beta} \right).$$

This is the result for  $\eta_0(x_1) = f(x_1)$  using the Fourier-Bessel expansion with (5.56). The key relation to the correspondence is of course the approximation (5.59).

## **5.8 Weather fronts**

82

In the atmosphere when a layer of cold air pushes under a layer of warmer air, a wedge shaped region of cold air is often formed; it is controlled by the Coriolis forces. Disturbances running along the front of this wedge have important meteorological effects. In an ideal situation (the formulation of approximate equations given in Stoker [10], Chapter 10.11), these are like the above edge waves, and the analysis in Laguerre polynomials is similar. This gives further stimulation for the interest in this kind of wedge problem.





## Chapter 6

# Full Theory of Water Waves

IN CHAPTERS 43 AND 5 we considered the approximate shallow water theory which has some advantages of simplicity, but also some inadequacies such as the behavior off-shore from a sloping beach. Here we deal with the full theory and some of its solutions. 83

### 6.1 Conservation equations and the boundary value problem

Consider a 3-dimensional flow of water on a general sloping bottom. We assume that the water is inviscid and neglect surface tension. Let  $V$  be a volume element enclosed in a smooth surface  $S$  in the fluid. Let  $\underline{u}(\underline{x}, t)$  be the velocity of the fluid particle at the position  $\underline{x}$  at time  $t$ . Let  $\rho(\underline{x}, t)$  and  $p(\underline{x}, t)$  denote the density and pressure of the fluid particle at  $\underline{x}$  at time  $t$ . The outward drawn unit normal to the surface  $S$  is denoted by  $\underline{n}$ . The equation of conservation of mass is

$$(6.1) \quad \frac{d}{dt} \int_V \rho dV = - \int_S \rho n_j u_j dS.$$

We assume that all the quantities are sufficiently smooth. Then using

the divergence theorem we obtain

$$(6.2) \quad \int_V \frac{\partial \rho}{\partial t} dV + \int_V \frac{\partial}{\partial x_j} (\rho u_j) dV = 0.$$

Here the summation convention is used for repeated indices and this will be adopted throughout.

84 Since (6.2) is true for all volume elements  $V$  and the functions are smooth it follows that

$$(6.3) \quad \frac{\partial \rho}{\partial t} + \frac{\partial}{\partial x_j} (\rho u_j) = 0.$$

Equation (6.3) is the mass conservation equation or 'continuity equation'.

We now derive the momentum equation. If  $F$  denotes the body force per unit mass acting on the volume  $V$ , then the conservation of momentum in the  $i^{\text{th}}$  direction can be expressed by

$$(6.4) \quad \frac{d}{dt} \int_V \rho u_i dV = - \int_S (\rho u_i) n_j u_j dS - \int_S n_i p dS + \int_V F_i \rho dV$$

The first term on the right hand side of (6.4) denotes the transport of momentum, the second term the surface force acting on  $S$  and the third term the body force acting on  $V$ . Equation (6.4) can be written as

$$\frac{d}{dt} \int_V \rho u_i dV + \int_S (\rho u_i u_j + p \delta_{ij}) n_j dS = \int_V F_i \rho dV.$$

Using the divergence theorem, we have

$$\int_V \left\{ \frac{\partial}{\partial t} (\rho u_i) + \frac{\partial}{\partial x_j} (u_i u_j + p \delta_{ij}) - \rho F_i \right\} dV = 0.$$

Since this is true for all  $V$  we obtain

$$(6.5) \quad \frac{\partial}{\partial t} (\rho u_i) + \frac{\partial}{\partial x_j} (\rho u_i u_j) + \frac{\partial p}{\partial x_i} = \rho F_i.$$

Under normal conditions for water waves it is reasonable to assume that  $\rho = \text{constant}$ . This together with (6.3) implies

$$(6.6) \quad \frac{\partial u_j}{\partial x_j} = 0.$$

85

Using (6.6) and  $\rho = \text{constant}$ , the momentum equation (6.5) can be written as

$$(6.7) \quad \frac{\partial u_i}{\partial t} + u_j \frac{\partial u_i}{\partial x_j} = -\frac{1}{\rho} \frac{\partial p}{\partial x_i} + F_i.$$

In water waves the body force  $\underline{F}$  is the gravitational acceleration  $g$  acting vertically downwards. We shall eventually use a mixed notation with the vertical coordinate replaced by  $y$ . With that in mind (but not making the change yet), we denote the unit vector in the vertical direction by  $\underline{j}$ . Then

$$(6.8) \quad \underline{F} = -g\underline{j}.$$

**Potential flow .**

In vector notation, the equations (6.6) and (6.7) are

$$(6.9) \quad \nabla \cdot \underline{u} = 0,$$

$$(6.10) \quad \frac{\partial \underline{u}}{\partial t} + (\underline{u} \cdot \nabla) \underline{u} = -\frac{1}{\rho} \nabla p - g\underline{j}.$$

The vorticity is defined by

$$(6.11) \quad \underline{\omega} = \nabla \times \underline{u};$$

if (6.9) is first written as

$$(6.12) \quad \frac{\partial \underline{u}}{\partial t} + \nabla \left( \frac{1}{2} \underline{u}^2 \right) + \underline{\omega} \times \underline{u} = -\frac{1}{\rho} \nabla p - g\underline{j},$$

and then the curl is taken, we obtain

$$(6.13) \quad \frac{\partial \underline{\omega}}{\partial t} + (\underline{u} \cdot \nabla) \underline{\omega} = (\underline{\omega} \cdot \nabla) \underline{u}.$$

It is clear that  $\underline{\omega} \equiv 0$  is a solution of this vorticity equation. Furthermore, if  $\underline{\omega} = 0$  for  $t = 0$  then (under mild conditions on  $\nabla \underline{u}$ )  $\underline{\omega} \equiv 0$  for all  $t$ . 86

Hence we assume that  $\underline{\omega} \equiv 0$ ; i.e. the flow is 'irrotational'. This implies

$$(6.14) \quad \underline{u} = \nabla \phi$$

for some scalar field  $\phi$ ;  $\phi$  is called the velocity potential.

The first equation (6.9) then gives

$$(6.15) \quad \nabla^2 \phi = 0,$$

and the second equation (6.10) becomes

$$\nabla \left( \frac{\partial \phi}{\partial t} \right) + \nabla \left( \frac{1}{2} u^2 \right) + \nabla \left( \frac{p}{\rho} \right) + \nabla (gy) = 0,$$

*i.e.*  $\frac{\partial \phi}{\partial t} + \frac{1}{2} (\nabla \phi)^2 + \frac{p - p_0}{\rho} + gy = \text{function of } t.$

Without loss of generality we can set this function of  $t$  to be zero since otherwise it can be absorbed in  $\phi$ , but it will be convenient to keep an arbitrary constant  $p_0$ . We have

$$(6.16) \quad \frac{p_0 - p}{\rho} = \frac{\partial \phi}{\partial t} + \frac{1}{2} (\nabla \phi)^2 + gy.$$

Relation (6.16) gives the pressure  $p$  in terms of the potential  $\phi$ .

### Boundary conditions .

At the bottom surface (or any other fixed solid surface), the normal velocity must be zero, so we have

$$(6.17) \quad \underline{u} \cdot \underline{n} = \frac{\partial \phi}{\partial n} = 0.$$

87 At the free surface of the water we give two conditions. They are coupled, but we may think of one as essentially determining the free surface, and the other as a boundary condition for (6.15).

The first one is obtained from the defining property of the free surface, namely that

(6.18) normal velocity of the surface = normal velocity of the fluid.

To implement this, let the water surface at time  $t$  be given by

(6.19) 
$$f(x_1, x_2, x_3, t) = 0.$$

In terms of  $f$  we have:

(6.20) 
$$\begin{aligned} \text{Unit normal vector } \underline{n} &= \frac{\nabla f}{|\nabla f|}, \\ \text{Normal velocity of surface} &= -\frac{f_t}{|\nabla f|}. \end{aligned}$$

(To show (6.20) we consider two successive positions of the surface at times  $t$  and  $t + dt$ . Points  $\underline{x}$  on the first and  $\underline{x} + \underline{n} ds$  on the second are separated by distance  $ds$  along the normal. We have

$$\begin{aligned} f(\underline{x}, t) &= 0 \\ f(\underline{x} + \underline{n} ds, t + dt) &= f(\underline{x}, t) + (\underline{n} \cdot \nabla f) ds + f_t dt + \dots \\ &= 0. \end{aligned}$$

Therefore

$$\frac{ds}{dt} = -\frac{f_t}{|\nabla f|},$$

and this is the normal velocity). Thus (6.18) implies

(6.21) 
$$\begin{aligned} \underline{u} \cdot \frac{\nabla f}{|\nabla f|} &= -\frac{f_t}{|\nabla f|}, \\ \text{i.e. } f_t + u_1 \frac{\partial f}{\partial x_1} + u_2 \frac{\partial f}{\partial x_2} + u_3 \frac{\partial f}{\partial x_3} &= 0. \end{aligned}$$

We now introduce the mixed notation, in which  $y$  is the vertical coordinate and  $v$  is the vertical velocity, and take  $x_3 \equiv y, u_3 \equiv v$ . Then if  $f$  is specialized to

$$f(x_1, x_2, x_3, t) = \eta(x_1, x_2, t) - y,$$

(6.21) becomes

$$\eta_t + \phi_{x_1} \eta_{x_1} + \phi_{x_2} \eta_{x_2} = v$$

At the surface

$$(6.22) \quad y = \eta(x_1, x_2),$$

we have

$$(6.23) \quad \eta_t + \phi_{x_1} \eta_{x_1} + \phi_{x_2} \eta_{x_2} = v.$$

The second boundary condition (if surface tension is ignored) is that the pressure in the water must equal the pressure in the air at the interface. Since the changes in air pressure are small (because its density is small), it is a good approximation to take the air pressure to be a constant  $p_0$ . If this is taken as the  $p_0$  in (6.16), the boundary condition becomes

$$\phi_t + \frac{1}{2}(\nabla\phi)^2 + g\eta = 0.$$

Thus the full boundary value problem is formulated as follows

$$(6.24) \quad \left. \begin{aligned} \nabla^2\phi &= 0, \\ \frac{\partial\phi}{\partial n} &= 0 \quad \text{at the bottom surface,} \\ \phi_t + \frac{1}{2}(\nabla\phi)^2 + g\eta &= 0 \quad \text{at } y = \eta(x_1, x_2, t), \end{aligned} \right\}$$

89 where the surface  $y = \eta(x_1, x_2, t)$  is determined by

$$(6.25) \quad \eta_t + \phi_{x_1} \eta_{x_1} + \phi_{x_2} \eta_{x_2} = \phi_y.$$

## 6.2 Linearized theory

Assume  $\phi, \nabla\phi, \phi_t, \eta$ , etc., are all small, i.e. consider small disturbances. To the first order approximation the boundary conditions at the free surface become

$$(6.26) \quad \left. \begin{aligned} \eta_t &= \phi_y, \\ \phi_t + g\eta &= 0, \end{aligned} \right\} \text{at } y = 0.$$

These can be combined into

$$(6.27) \quad \phi_{tt} + g\phi_y = 0 \quad \text{at} \quad y = 0.$$

Assuming the bottom surface to be horizontal, the boundary condition at the bottom surface becomes

$$(6.28) \quad \phi_y = 0 \quad \text{at} \quad y = -h_0.$$

In the case of one dimensional waves, let

$$(6.29) \quad \phi = \Phi(y)e^{ikx - i\omega t}$$

be a solution of (6.15), (6.27), (6.28). Then the ordinary differential equation satisfied by  $\Phi$  is

$$(6.30) \quad \Phi_{yy} - k^2\Phi = 0,$$

and we have

$$(6.31) \quad \text{Free surface:} \quad \Phi_y - \frac{\omega^2}{g}\Phi = 0 \quad \text{at} \quad y = 0,$$

$$(6.32) \quad \text{Bottom:} \quad \Phi_y = 0 \quad \text{at} \quad y = -h_0.$$

We note that

90

$$(6.33) \quad \Phi = \cos hk(h_0 + y),$$

is a solution of (6.30) and satisfies the boundary condition (6.32). The boundary condition at the free surface (6.31) is satisfied provided

$$(6.34) \quad \omega^2 = gk \tan hkh_0.$$

Equation (6.34) is an important relation called the “dispersion relation”. In (6.34)  $k$  denotes the wave number, the frequency of the wave and  $c = \frac{\omega}{k}$  the phase velocity. From (6.34) we obtain

$$(6.35) \quad c^2 = \frac{g}{k} \tan hkh_0.$$

From formula (6.35), we note that the phase velocity depends on  $k$ , which means that for a general disturbance the waves will disperse. The equations (6.26), (6.29) and (6.33) imply

$$\begin{aligned}\eta &= -\frac{1}{g}\phi_t|_y = 0 \\ &= \frac{i\omega}{g} \cos hkh_0 e^{ikx-i\omega t}.\end{aligned}$$

Hence a solution to the problem (6.24) in the linearized theory is

$$(6.36) \quad \left. \begin{aligned}\eta &= Ae^{ikx-i\omega t}, \\ \omega^2 &= gk \tan hkh_0, \\ &= -\frac{ig}{\omega} \frac{A \cos hkh_0}{\cos hkh_0} e^{ikx-i\omega t},\end{aligned} \right\}$$

91 where  $A = \frac{i\omega}{g} \cos hkh_0$ .

In the shallow water (long wave) theory the wave length  $\lambda = \frac{2\pi}{k}$  is large compared with  $h_0$ ; therefore  $kh_0 \ll 1$ . As  $kh_0 \rightarrow 0$ ,  $\tan hkh_0 \simeq kh_0$ , and we have

$$\omega \simeq \pm \sqrt{gh_0}k.$$

Hence

$$(6.37) \quad c \simeq \frac{\omega}{k} \simeq \pm \sqrt{gh_0}.$$

This is what we found in linear shallow water theory. The solution in this case is nondispersive and hyperbolic. This shows that the additional terms change the character of the wave. For a full discussion of the relation of shallow water theory to the full theory, see [1] Section 13.10.

In the other extreme of deep water, i.e.  $kh_0 \gg 1$ ,

$$(6.38) \quad \omega \simeq \pm \sqrt{gk} \quad \text{and} \quad c \simeq \pm \sqrt{\frac{g}{k}}.$$

Equation (6.38) tells us that the waves are still dispersive but simplifies the formula. Here

$$\phi \simeq -\frac{ig}{\omega} A e^{ky} e^{ikx-i\omega t} \quad (y < 0)$$



The above formulae give good results even when the depth is only about twice the wave length.

### Initial value problem .

We want to find the solution for  $\eta$  when the initial conditions

$$(6.39) \quad t = 0 : \begin{cases} \eta = \eta_0(x) \\ \eta_t = \eta_1(x) \end{cases}$$

are given. From (6.36) we see that  $\eta$  will be of the form

92

$$(6.40) \quad \eta = \int_{-\infty}^{\infty} A_1(k) e^{ikx - iW(k)t} dk + \int_{-\infty}^{\infty} A_2(k) e^{ikx - iW(k)t} dk,$$

where

$$(6.41) \quad W(k) = \{gk \tan h kh_0\}^{1/2}.$$

Equations (6.39) and (6.41) imply

$$\begin{aligned} \eta_0 &= \int_{-\infty}^{\infty} \{A_1(k) + A_2(k)\} e^{ikx} dk, \\ \eta_1 &= \int_{-\infty}^{\infty} iW(k) \{-A_1(k) + A_2(k)\} e^{ikx} dk. \end{aligned}$$

Using Fourier inversion theorem, we obtain

$$(6.42) \quad \begin{aligned} A_1 &= \frac{1}{2} \int_{-\infty}^{\infty} \left\{ \eta_0(x) - \frac{i}{W} \eta_1(x) \right\} e^{-ikx} dx, \\ A_2 &= \frac{1}{2} \int_{-\infty}^{\infty} \left\{ \eta_0(x) + \frac{i}{W} \eta_1(x) \right\} e^{-ikx} dx. \end{aligned}$$

Equations (6.41), (6.42) give the solution for the initial value problem.



## Chapter 7

# Waves on a Sloping Beach: Full Theory

WE NOW USE the full theory to consider some of the problems treated 93  
by the shallow water theory in Chapter 5, and obtain important modi-  
fications and extensions. These problems are considerably more com-  
plicated in the full theory and we shall consider only the linearized ap-  
proximation. As described in Chapter 6 we have to solve the following  
problem for the velocity potential:

$$(7.1) \quad \nabla^2 \phi = 0 \quad \text{in the fluid,}$$

$$(7.2) \quad \frac{\partial \phi}{\partial n} = 0 \quad \text{on bottom,}$$

$$(7.3) \quad \phi_y + \frac{1}{g} \phi_{tt} = 0 \quad \text{on } y = 0.$$

Then the surface elevation is given by

$$(7.4) \quad \eta = -\frac{1}{g} [\phi_t]_{y=0}.$$

### 7.1 Normal incidence

With  $x$  out to sea,  $y$  vertical, and beach angle  $\beta$ , we have

$$(7.5) \quad \phi_{xx} + \phi_{yy} = 0,$$

with the boundary conditions.

At the bottom:

$$(7.6) \quad x \sin \beta + y \cos \beta = 0 : \frac{\partial \phi}{\partial n} = \phi_x \sin \beta + \phi_y \cos \beta = 0.$$

On the top  $y = 0$ :

$$(7.7) \quad \phi_{tt} + g\phi_y = 0.$$

94

If  $\phi(x, y, t)$  is of the form

$$\phi(x, y, t) = S(x, y)e^{-i\omega t},$$

then (7.5)-(7.7) become

$$(7.8) \quad S_{xx} + S_{yy} = 0,$$

$$(7.9) \quad \text{Bottom: } S_x \sin \beta + S_y \cos \beta = 0, \\ \text{on } x \sin \beta + y \cos \beta = 0,$$

$$(7.10) \quad \text{Top: } S_y - \ell S = 0 \quad \text{on } y = 0,$$

where

$$\ell = \frac{\omega^2}{g}.$$

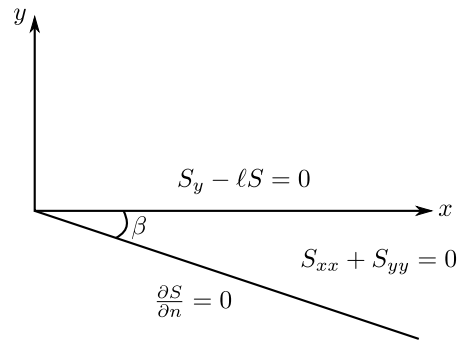

Figure 7.1:

Hanson in 1926 observed that when  $\beta = \frac{\pi}{2N}$  ( $N$  is an integer) an exact solution of the problem can be given as the sum of exponentials. For example in the special case  $\beta = \frac{\pi}{4}$ , ( $N = 2$ ), he obtained

$$(7.11) \quad S = \frac{1}{4}(1+i)e^{i\ell x+\ell y} + \frac{1}{4}(1+i)e^{-\ell x-i\ell y}, \\ + \frac{1}{4}(1+i)e^{-i\ell x+\ell y} + \frac{1}{4}(1-i)e^{-\ell x+i\ell y}.$$

95

The first and third terms are just deep water solutions, representing outgoing and incoming waves, respectively, but ignoring the bottom boundary condition (7.9). The second and fourth terms correct for the boundary condition and tend to zero as  $x \rightarrow \infty$  away from the shore. We note that the solution is regular at the shore, with perfect reflection. Thus it corresponds to the  $J_0$  solution of (5.16). This time we see that the amplitude at infinity is non-zero. The ratio of the amplitude at infinity (combined incident plus reflected) to the total amplitude at the shoreline is

$$(7.12) \quad \frac{a_\infty}{a_0} = \frac{1}{\sqrt{2}}.$$

In the 1940's Lewy and Stoker (see [10]) found a consistent way to generate these solutions for the special angles  $\beta = \pi/2N$  (and later for  $\beta = M\pi/2N$ ). As  $N$  increases, for small beach angles  $\beta$ , the number of exponentials becomes large. Asymptotics and various questions for  $\beta \ll 1$  become difficult with these formulas. However, Friedrichs [12] found a form which is useful for these and other purposes. The derivation is not given in the paper. It seems intirely possible that Friedrichs noted that sums of exponentials would follow from complex integrals of the form

$$\frac{1}{2\pi i} \int_C f(\zeta) e^{\zeta(x \pm iy)} d\zeta$$

when  $f(\zeta)$  is a meromorphic function, and observed which factors in  $f$  are needed to give the known results. For example it is easy to construct (7.11) with poles at  $\zeta = \pm i\ell$ . Here, we give an independent derivation, which is independent of previously known results. 96

First, by separation of variables, elementary solutions of Laplace's equation are

$$(7.13) \quad e^{\zeta x} \cdot e^{\pm i\zeta y}$$

and by superposition we obtain a general solution of the equation in (7.8) to be

$$(7.14) \quad S(x, y) = \frac{1}{4\pi i} \int_{\mathcal{C}} f(\zeta) e^{\zeta(x+iy)} d\zeta + \frac{1}{4\pi i} \int_{\mathcal{C}} g(\zeta) e^{\zeta(x-iy)} d\zeta$$

where  $\mathcal{C}$  is a contour in the complex plane to be chosen later. The form (7.14) is also immediately suggested by the fact that analytic functions of  $x + iy$  or  $x - iy$  satisfy Laplace's equation. If (7.14) satisfies the top boundary condition (7.10) then

$$\frac{1}{4\pi i} \int_{\mathcal{C}} \{(i\zeta - \ell)f(\zeta) - (i\zeta + \ell)g(\zeta)\} e^{\zeta x} d\zeta = 0.$$

Since this is true for all  $x$ , we obtain

$$(7.15) \quad g(\zeta) = \frac{\zeta + i\ell}{\zeta - i\ell} f(\zeta).$$

97 In order to find out the functional relation between  $f$  and  $g$  so that (7.14) satisfies the bottom boundary condition (7.9), it is convenient to introduce polar coordinates. Then on the bottom,

$$x = r \cos \beta, \quad y = -r \sin \beta,$$

the boundary condition (7.9) is satisfied by (7.14) if

$$\begin{aligned} & \frac{1}{4\pi i} \int_{\mathcal{C}} (\sin \beta + i \cos \beta) \zeta e^{\zeta r e^{-i\beta}} f(\zeta) d\zeta \\ & + \frac{1}{4\pi i} \int_{\mathcal{C}} (\sin \beta - i \cos \beta) \zeta e^{\zeta r e^{i\beta}} g(\zeta) d\zeta = 0, \end{aligned}$$

$$\text{i.e. } \frac{1}{4\pi} \int_{\mathcal{C}} e^{-i\beta} \zeta e^{\zeta r e^{-i\beta}} f(\zeta) d\zeta - \frac{1}{4\pi} \int_{\mathcal{C}} e^{i\beta} \zeta e^{\zeta r e^{i\beta}} f(\zeta) d\zeta = 0.$$

Using the transformation  $\zeta = \zeta' e^{2i\beta}$  for the first integral, we obtain

$$(7.16) \quad \frac{1}{4\pi} \int_{\mathcal{C}'} e^{2i\beta} \zeta' e^{\zeta' r e^{i\beta}} f(\zeta' e^{2i\beta}) d\zeta' - \frac{1}{4\pi} \int_{\mathcal{C}} \zeta e^{\zeta r e^{i\beta}} g(\zeta) d\zeta = 0.$$

where  $\mathcal{C}'$  is the image of  $\mathcal{C}$  under the map  $\zeta \rightarrow \zeta' e^{2i\beta}$ .

If  $\mathcal{C}'$  can be deformed back to  $\mathcal{C}$  without crossing singularities then (7.16) can be replaced by

$$\frac{1}{4\pi} \int_{\mathcal{C}} [f(\zeta e^{2i\beta}) e^{2i\beta} - g(\zeta)] \zeta e^{\zeta r e^{i\beta}} d\zeta = 0.$$

This gives

$$(7.17) \quad g(\zeta) = e^{2i\beta} f(\zeta e^{2i\beta}).$$

If we combine (7.15) and (7.17) we have the functional relation

$$(7.18) \quad f(\zeta) = e^{2i\beta} \frac{\zeta - i\ell}{\zeta + i\ell} f(\zeta e^{2i\beta})$$

for  $f(\zeta)$ .

**Special case**  $\beta = \pi/2N$  .

98

It will be convenient in this case, to define  $w$  as

$$(7.19) \quad w = e^{2i\beta} = e^{\pi i/N}$$

with the properties

$$(7.20) \quad w^N = -1, \quad w^{2N} = 1.$$

Then (7.18) becomes

$$(7.21) \quad f(\zeta) = \frac{\zeta - i\ell}{\zeta + i\ell} w f(w\zeta).$$

If this relation is applied  $2N$  times to relate  $f(\zeta)$  to  $f(w^{2N}\zeta)$  the accumulated factors cancel and we deduce only that  $f(\zeta)$  is single-valued. If we apply it  $N$  times to relate  $f(\zeta)$  to  $f(w^N\zeta)$ , we have

$$(7.22) \quad f(\zeta) = -\frac{(\zeta - i\ell)(w\zeta - i\ell)\dots(w^{N-1}\zeta - i\ell)}{(\zeta + i\ell)(w\zeta + i\ell)\dots(w^{N-1}\zeta + i\ell)}f(-\zeta),$$

since  $w^N = -1$ . In the multiplying function, we observe that the numerator  $\mathcal{N}(\zeta) = (-1)^N \mathcal{D}(-\zeta)$  where  $\mathcal{D}(\zeta)$  is the denominator, so that solutions for  $f(\zeta)$  are easily read off. First it is convenient to modify (7.22) to

$$(7.23) \quad f(\zeta) = -\frac{(\zeta + i\ell w)(\zeta + i\ell w^2)\dots(\zeta + i\ell w^N)}{(\zeta - i\ell w)(\zeta - i\ell w^2)\dots(\zeta - i\ell w^N)}f(-\zeta),$$

by taking out factors in  $w$ , using

$$w^{-m} = -w^{N-m}$$

and re-ordering. We then observe that

$$(7.24) \quad f(\zeta) = \frac{\zeta^{N-1}}{(\zeta - i\ell w)(\zeta - i\ell w^2)\dots(\zeta - i\ell w^N)}$$

- 99** is a solution, the factor  $\zeta^{N-1}$  (or some equivalent) being necessary to adjust the spare powers of  $-1$ . We check that this not only satisfies (7.23), but also the original (7.21). We show that this leads to a satisfactory solution for  $S(x, y)$  and then return to consider its uniqueness.

We introduce

$$(7.25) \quad \zeta_n = i\ell w^n = i\ell e^{n\pi i/N},$$

and write

$$(7.26) \quad f(\zeta) = \frac{\zeta^{N-1}}{(\zeta - \zeta_1)\dots(\zeta - \zeta_N)}.$$



Then, from (7.15),

$$(7.27) \quad g(\zeta) = \frac{\zeta^{N-1}}{(\zeta - \zeta_0) \dots (\zeta - \zeta_{N-1})}.$$

The solution (7.14) becomes

$$(7.28) \quad S(x, y) = \frac{1}{4\pi i} \int_{\mathcal{C}} \frac{\zeta^{N-1} e^{\zeta(x+iy)}}{(\zeta - \zeta_1) \dots (\zeta - \zeta_N)} d\zeta + \frac{1}{4\pi i} \int_{\mathcal{C}} \frac{\zeta^{N-1} e^{\zeta(x-iy)}}{(\zeta - \zeta_0) \dots (\zeta - \zeta_{N-1})} d\zeta.$$

In particular, on the surface  $y = 0$ ,

$$(7.29) \quad S(x, 0) = \frac{1}{2\pi i} \int_{\mathcal{C}} \frac{\zeta^N e^{\zeta x}}{(\zeta - \zeta_0) \dots (\zeta - \zeta_N)} d\zeta;$$

the surface elevation is given by

$$(7.30) \quad \eta(x, t) = \frac{i\omega}{g} S(x, 0) e^{-i\omega t}.$$

### Solution regular at the shoreline.

100

The singularities in (7.28) are poles at

$$\zeta = \zeta_n = il e^{\pi i n / N}, \quad n = 0, \dots, N;$$

they lie on the semicircle  $\Re \zeta \leq 0$  shown in Fig. 7.2. If  $\mathcal{C}$  is taken to be a contour enclosing all these poles then the important condition following (7.16) that, after rotation,  $\mathcal{C}'$  should be deformable back to  $\mathcal{C}$  is satisfied. With this contour,  $S(x, y)$  is bounded for all  $x$  and  $y$ , and is regular at the shoreline. In fact expanding the integral as the sum of the residues at the poles we have contributions involving only exponentials  $e^{\zeta_n(x \pm iy)}$

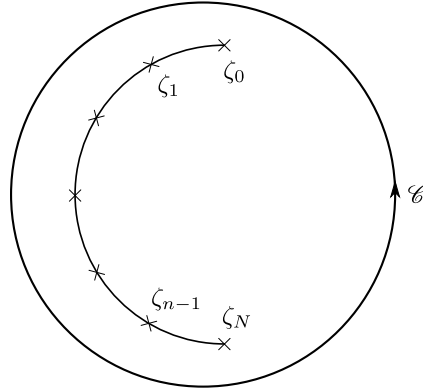

Figure 7.2:

All these have acceptable behavior as  $x \rightarrow \infty$  since  $\Re \zeta_n \leq 0$  for  $n = 0, 1, \dots, N$ . In particular

$$(7.31) \quad S(x, 0) = \sum_0^N c_n e^{\zeta_n x},$$

where

$$c_n = \frac{\zeta_n^N}{(\zeta_n - \zeta_0) \dots (\zeta_n - \zeta_N)},$$

101 omitting the zero factor in the denominator.

**Value at shoreline.**

From (7.29)

$$S(0, 0) = \frac{1}{2\pi i} \int_{\mathcal{C}} \frac{\zeta^N}{(\zeta - \zeta_0) \dots (\zeta - \zeta_N)} d\zeta.$$

Taking  $\mathcal{C}$  to be a large contour and noting that the integrand is  $\sim 1/\zeta$  as  $\zeta \rightarrow \infty$ , we have

$$(7.32) \quad S(0, 0) = 1.$$

Of course any multiple of  $S(x, y)$  is also a solution.

**Behavior as  $x \rightarrow \infty$ .**

Since  $\Re \zeta_n < 0$  except for  $\zeta_0 = i\ell$  and  $\zeta_N = -i\ell$ , the asymptotic behavior of the solution as  $x \rightarrow \infty$  is given by the latter. We have, from the residues at  $\pm i\ell$ ,

$$(7.33) \quad S(x, y) \sim \frac{1}{2D^*} e^{-i\ell x + \ell y} + \frac{1}{2D} e^{i\ell x + \ell y},$$

where

$$(7.34) \quad D = (1 - w)(1 - w) \dots (1 - w^{N-1}), w = e^{\pi i/N},$$

and  $D^*$  denotes complex conjugate of  $D$ . This shows the equal amplitude of incoming and outgoing waves; we have perfect reflection. We can also write

$$(7.35) \quad S(x, 0) \sim \frac{1}{|D|} \cos(\ell x - \arg D).$$

102

**The amplitude factor  $D$ .**

The product  $DD^*$  contains all the  $2N$ th roots of unity except  $+1$  and  $-1$ . Therefore

$$DD^* = \lim_{W \rightarrow 1} \frac{W^{2N} - 1}{(W - 1)(W + 1)} = N.$$

Moreover,

$$\frac{D}{D^*} = \frac{(1 - w) \dots (1 - w^{N-1})}{(1 - w^*) \dots (1 - w^{*N-1})}.$$

But

$$\frac{1 - w^n}{1 - w^{*n}} = \frac{1 - w^n}{1 - w^{-n}} = -w^n.$$

Hence

$$\begin{aligned} \frac{D}{D^*} &= (-1)^{N-1} w \cdot w \dots w^{N-1} = (-1)^{N-1} w^{\frac{N(N-1)}{2}} \\ &= e^{-\pi i(N-1)/2}. \end{aligned}$$

Therefore

$$(7.36) \quad D = N^{1/2} e^{-\pi i \frac{N-1}{4}}.$$

We note that the ratio of amplitudes is

$$(7.37) \quad \frac{a_\infty}{a_0} = \frac{1}{N^{1/2}} = \left(\frac{2\beta}{\pi}\right)^{1/2}.$$

Since this holds for a sequence  $\beta = \pi/2N$  converging to zero, if  $a_\infty/a_0$  is an analytic function of  $\beta$ , this formula holds for all  $\beta$ . The formula checks with (7.12), and was quoted in the discussion of Section 5.3.

### 103 Singular solutions .

In view of the following conditions on  $\mathcal{C}$ :

- (a) After a rotation through  $2\beta$  to a new path  $\mathcal{C}'$ ,  $\mathcal{C}'$  must be deformable back to the original  $\mathcal{C}$  without crossing a singularity;
- (b) A path going to  $\infty$  must have  $\Re \zeta < 0$  as  $\zeta \rightarrow \infty$ , in order that the integrals in (7.28) be convergent for  $x > 0$ ;

the only other choices of contour are  $\mathcal{C}_1$  or  $\mathcal{C}_2$ , shown in Fig. 7.3, or some combination.

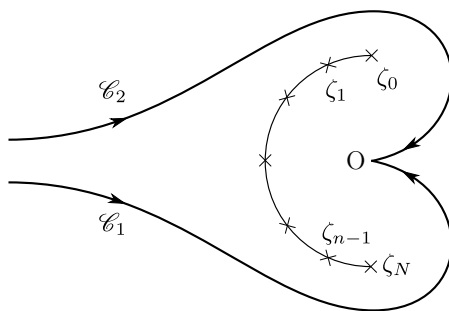

Figure 7.3:

We consider  $S_1(x, 0)$  in (7.29) for the path  $\mathcal{C}_1$ .

Since the integrand  $\sim 1/\zeta$  as  $\zeta \rightarrow \infty$ , the convergence of the integral is lost when  $x = 0$ . Accordingly  $S(x, 0)$  is singular at the shoreline. We may write

$$\begin{aligned}
 S_1(x, 0) &= \frac{1}{2\pi i} \int_{-\infty}^A \frac{e^{\zeta x}}{\zeta} d\zeta + 0(1), \quad x \rightarrow 0 \\
 &= \frac{1}{2\pi i} \int_{Ax}^{\infty} e^{-\xi} \frac{d\xi}{\xi} + 0(1), \quad \text{where } \zeta = -\frac{\xi}{x} \\
 &= \frac{1}{2\pi i} \int_{Ax}^1 \frac{d\xi}{\xi} + 0(1), \\
 (7.38) \quad &= -\frac{1}{2\pi i} \log x + 0(1),
 \end{aligned}$$

so the singularity is logarithmic.

104

We may also use partial fractions and write

$$\begin{aligned}
 S_1(x, 0) &= \sum_{n=0}^N c_n \frac{1}{2\pi i} \int_{\mathcal{C}_1} \frac{e^{\zeta x}}{\zeta - \zeta_n} d\zeta \\
 (7.39) \quad &= \sum_{\Im \zeta_n \leq 0} c_n e^{\zeta_n x} + \sum_{\Im \zeta_n > 0} c_n \frac{1}{2\pi i} \int_{-\infty}^0 \frac{e^{\zeta x}}{\zeta - \zeta_n} d\zeta.
 \end{aligned}$$

(The latter integral is indented above the pole at  $\zeta_{N/2}$  in the case  $N$  is even). The transformation  $\zeta = \zeta_n - \zeta/x$  converts the final integrals into standard exponential integrals.

As  $x \rightarrow \infty$ , the dominant term in (7.39) is from the pole at  $\zeta_N = -il$ . Therefore,

$$(7.40) \quad S_1(x, 0) \sim c_N e^{-ilx}, \quad x \rightarrow \infty.$$

Thus  $S_1(x, 0)$  represents a purely incoming wave with loss of energy at the beach.

Similarly, if  $\mathcal{C}_2$  (Fig. 7.3) is taken in (7.29), the corresponding solution  $S_2(x, 0)$  represents a purely outgoing wave, with logarithmic singularity at the shoreline.

The correspondence with the Bessel functions of the shallow water theory, Section 5.3, is

$$(7.41) \quad \begin{aligned} S(x, 0) &= S_1(x, 0) - S_2(x, 0) \leftrightarrow J_0, \\ S_1(x, 0) + S_2(x, 0) &\leftrightarrow -iY_0. \end{aligned}$$

#### 105 Uniqueness of the solution of the functional relation for $f(\zeta)$ .

One could show that the uniqueness of the solutions  $S(x, y)$ ,  $S_1(x, y)$ ,  $S_2(x, y)$ , under the various conditions at  $x = 0$  and  $x \rightarrow \infty$ , by direct arguments. However it is interesting to consider the uniqueness of the solution to the functional equation (7.21) directly. This is especially so, since important alternative solutions arise in the corresponding case for oblique incidence, which we consider in Section 7.5.

If  $f(\zeta)$  is set equal to  $G(\zeta)$  times the expression in (7.24) and substituted in (7.21), it follows that

$$(7.42) \quad G(\zeta) = G(w\zeta), \quad w = e^{\pi i/N}.$$

Clearly  $G(\zeta) = H(\zeta^{2N})$  is a solution for any single valued function  $H(z)$ . It is also the only solution under reasonable hypotheses.

*Proof.* We know that  $G(\zeta)$  is single-valued. Suppose that it has a Laurent expansion in some annular region, i.e.

$$(7.43) \quad G(\zeta) = \sum_{-\infty}^{\infty} a_m \zeta^m.$$

Then

$$\begin{aligned} a_m &= \frac{1}{2\pi i} \oint \frac{G(s)}{s^{m+1}} ds \\ &= \frac{1}{2\pi i} \oint \frac{G(wt)}{t^{m+1}} dt \cdot \frac{1}{w^m}, \quad s = wt, \\ &= \frac{1}{2\pi i} \oint \frac{G(t)}{t^{m+1}} dt \cdot \frac{1}{w^m}, \quad \text{from (7.42),} \end{aligned}$$

$$= \frac{a_m}{w^m}$$

Therefore  $a_m = 0$  unless  $m = 0, \pm 2N, \pm 4N, \dots$ . Thus from (7.43), 106

$$G(\zeta) = H(\zeta^{2N})$$

where  $H(z)$  is a single-valued function.

Although the solution of (7.21) is non-unique to this extent, the extra possibility does not appear to affect  $S(x, y)$ . We consider the case where  $\mathcal{C}$  is a closed contour and include the extra factor  $H(\zeta^{2N})$  in (7.28). If  $H(\zeta^{2N})$  is analytic inside  $\mathcal{C}$ , the residues at  $\zeta_n$  have an extra factor  $H(\zeta_n^{2N})$ . Since  $\zeta_n^{2N} = (i\ell)^{2N}$ , this is independent of  $n$  and leads only to a constant factor multiplying  $S(x, y)$ . If  $H(z)$  has a pole at the origin, then  $H(\zeta^{2N}) \propto \zeta^{-m}$  where  $m$  is at least  $2N$ . The residue would lead to positive powers of  $x$  and  $y$  in  $S(x, y)$ ; these are unacceptable. If  $H(z)$  has a pole at  $z = A$ , then  $H(\zeta^{2N})$  has poles at  $\zeta = A^{1/2N}$ . Some of these have  $\Re \zeta > 0$  and lead to exponentials with positive exponent in  $S(x, y)$ ; again they are unacceptable for a physical solution.  $\square$

## 7.2 The shallow water approximation

Let  $\beta \rightarrow 0$  in such a manner that  $\frac{\ell}{\beta}x$  is fixed and let  $\zeta = \frac{\ell}{\beta}\eta$  in (7.29). Then

$$S(x, 0) = \frac{1}{2\pi i} \int_{\mathcal{C}} \frac{e^{\ell x \eta / \beta} d\eta}{\eta \left(1 - \frac{\beta \zeta_0}{\ell \eta}\right) \dots \left(1 - \frac{\beta \zeta_N}{\ell \eta}\right)}$$

Now

$$\begin{aligned} & \log \left\{ \left(1 - \frac{\beta \zeta_0}{\ell \eta}\right) \dots \left(1 - \frac{\beta \zeta_N}{\ell \eta}\right) \right\} \\ &= \log \left(1 - \frac{\beta \zeta_0}{\ell \eta}\right) + \dots + \log \left(1 - \frac{\beta \zeta_N}{\ell \eta}\right) \\ &= -\frac{\beta}{\ell \eta} (\zeta_0 + \dots + \zeta_N) + O(\beta^2 N) \\ &= -\frac{i\beta}{\eta} (1 + w + \dots + w^N) + O(\beta) \end{aligned}$$

$$\begin{aligned}
&= -\frac{i\beta}{\eta} \frac{w^{N+1} - 1}{w - 1} + 0(\beta) \\
&= +\frac{i\beta}{\eta} \frac{w + 1}{w - 1} + 0(\beta).
\end{aligned}$$

107

Since

$$w = e^{\frac{\pi i}{N}} = 1 + \frac{\pi i}{N} + 0\left(\frac{1}{N^2}\right)$$

we have

$$\frac{w + 1}{w - 1} = \frac{2N}{\pi i} + 0(\beta).$$

Hence

$$(7.44) \quad \log\left(1 - \frac{\beta\zeta_0}{\ell\eta}\right) \dots \left(1 - \frac{\beta\zeta_N}{\ell\eta}\right) = \frac{1}{\eta} + 0(\beta).$$

Therefore

$$\begin{aligned}
(7.45) \quad S(x, 0) &\sim \frac{1}{2\pi i} \int_{\mathcal{C}} \frac{\exp\left(\frac{\ell x}{\beta}\eta - \frac{1}{\eta}\right)}{\eta} d\eta \\
&= J_0\left(2\sqrt{\frac{\ell x}{\beta}}\right), \quad \ell = \frac{\omega^2}{g}.
\end{aligned}$$

This is the solution we obtained in shallow water theory.

Since this is the asymptotic behavior with  $\ell x/\beta$  held fixed, it is appropriate only for  $x = 0(\beta)$ .

### 7.3 Behavior as $\beta \rightarrow 0$

108

Friedrichs [12] obtained improved approximations for small beach angles. The main step is to improve on the approximation (7.44), but we



work with different variables. It is convenient to set  $\zeta = iz$  in (7.29) and work with the form

$$(7.46) \quad S(x) = \frac{1}{2\pi i} \int_{\mathcal{C}} \frac{z^N e^{izx}}{(z - z_0) \dots (z - z_N)} dz, \quad z_n = \ell e^{\pi i n/N}.$$

Now, for large  $N$  (small  $\beta$ ),

$$\frac{1}{2} \log \left(1 - \frac{z_0}{z}\right) + \log \left(1 - \frac{z_1}{z}\right) + \dots + \log \left(1 - \frac{z_{N-1}}{z}\right) + \frac{1}{2} \log \left(1 - \frac{z_N}{z}\right)$$

is a Riemann sum approximation to the integral

$$(7.47) \quad N \int_0^1 \log \left(1 - \frac{\ell e^{\pi i \sigma}}{z}\right) d\sigma,$$

taking the dissection  $\sigma = n/N$  and  $d\sigma = 1/N$ . If we let this be  $2NiF(z)/\pi = iF(z)/\beta$ , so that

$$(7.48) \quad F(z) = \frac{\pi}{2i} \int_0^1 \log \left(1 - \frac{\ell e^{\pi i \sigma}}{z}\right) d\sigma,$$

we have

$$(7.49) \quad S(x) \sim \frac{1}{2\pi i} \int_{\mathcal{C}} \frac{e^{izx - \frac{i}{\beta} F(z)}}{(z - \ell)^{1/2} (z + \ell)^{1/2}} dz.$$

(Note  $z_0 = \ell, z_N = -\ell$ .)

Expression (7.49) is valid for small  $\beta$ , irrespective of  $x$ . But further approximations can now be made. The shallow water result, for example, corresponds to the approximation

$$F(z) \sim -\frac{\ell}{z} \quad \text{for large } z.$$

The main approximation that Friedrichs considered is the limiting behavior  $\beta \rightarrow 0$  with the depth  $\beta x$  fixed. The precise form is  $\ell\beta x$  fixed, but we will not trouble to normalize the variables completely. The exponent in (7.49) is

$$\frac{1}{\beta}(\beta x z - F(z)),$$

so the saddle point method can be applied for  $\beta \rightarrow 0$ ,  $\beta x$  fixed. It is convenient first to simplify (7.48) by the substitution  $\tau = ze^{-\pi i \sigma}$  to give

$$(7.50) \quad F(z) = \frac{1}{2} \int_0^z \frac{1}{\tau} \log \frac{\tau + \ell}{\tau - \ell} d\tau.$$

Then the saddle points  $z = \pm\kappa$ ,  $\kappa > \ell > 0$ , satisfy

$$(7.51) \quad \beta x = F'(\kappa) = \frac{1}{2\kappa} \log \frac{\kappa + \ell}{\kappa - \ell}$$

$$(7.52) \quad = \frac{1}{\kappa} \tan h^{-1} \frac{\ell}{\kappa}.$$

We note that  $\kappa$  is a function of  $x$  and (7.52) can be re-written

$$(7.53) \quad \ell = \frac{\omega^2}{g} = \kappa \tan h \kappa \beta x.$$

This is exactly the relation (6.34) with  $h_0 = \beta x$ , so that  $\kappa(x)$  is the local wave number. This is confirmed in the full saddle point approximation to (7.49). We have

$$(7.54) \quad S(x) \sim \left(\frac{\beta}{2\pi}\right)^{1/2} \frac{e^{i\theta(x)}}{\{(\kappa^2 - \ell^2) |F''(\kappa)|\}^{1/2}}$$

where

$$(7.55) \quad \theta(x) = \kappa x - \frac{1}{\beta} F(\kappa).$$

**110** Then, the local wave number discussed in (5.14) is

$$\theta_x = \kappa + \left\{ x - \frac{1}{\beta} F'(\kappa) \right\} \frac{d\kappa}{dx} = \kappa,$$

from (7.51). So we see that the local wavenumber changes with respect to  $x$  according to (7.53), this would be expected in advance and has often been used as a direct approximation. The amplitude factor in (7.54) also has a simple interpretation. It can be shown that it satisfies

$$(7.56) \quad A^2 C(\kappa) = \text{constant},$$

where  $C(\kappa)$  is the group velocity  $\partial\omega/\partial\kappa$ . This is a statement of constant energy flux, and again has often been used directly.

The approximation in (7.53)-(7.55) overlaps with the shallow water approximation (7.45) as  $\beta x \rightarrow 0$  and gives the correct asymptotic behavior at infinity ( $\beta x \rightarrow \infty$ ). In a typical case of  $\beta = 6^\circ$ , numerical work on the exact solution showed that the shallow water result was good from the shoreline to a distance out of two wavelengths, whereas (7.53)-(7.55) applied from about one third of a wavelength out to infinity.

## 7.4 General $\beta$

We note that (7.18) can in fact be solved in terms of an integral for all values of  $\beta$ . This was obtained by Peters [13]. The form appears to make it difficult to use in any very practical way, so we just quote the result:

$$(7.57) \quad \log \{ \zeta f(\zeta) \} = \frac{1}{2\pi i} \int_0^\infty \log \left( \frac{z - i\ell}{z + i\ell} \right) \cdot \frac{\pi}{\beta} \frac{z^{\frac{\pi}{\beta} - 1}}{z^{\pi/\beta} - \zeta^{\pi/\beta}} dz$$

in  $0 < \arg \zeta < 2\beta$ , with suitable analytic continuation.

111

## 7.5 Oblique incidence and edge waves

We now consider solutions that include dependence on the longshore co-ordinate, which is taken to be  $x_2$ . These will include waves with

oblique incidence at infinity, and edge waves trapped near the shore. In (7.1)-(7.3), we take <sup>1</sup>

$$(7.58) \quad \phi(x, x_2, y, t) = S(x, y)e^{ikx_2 - i\omega t},$$

and the problem for  $S(x, y)$  is to solve

$$(7.59) \quad S_{xx} + S_{yy} - k^2 S = 0,$$

with boundary conditions

$$(7.60) \quad \text{Top } y = 0 : S_y - \lambda S = 0, \lambda = \omega^2/g.$$

$$(7.61) \quad \text{Bottom } x \sin \beta + y \cos \beta = 0 : S_x \sin \beta + S_y \cos \beta = 0.$$

Again Hanson [11] had found solutions as the sum of exponentials in some special cases  $\beta = \pi/2N$ . For  $\beta = \pi/4$  he had

$$(7.62) \quad S(x, y) = \frac{1}{4} \left( 1 + \frac{i\lambda}{\ell} \right) \left\{ e^{i\ell x + \lambda y} + e^{-\lambda x - i\ell y} \right\} + \text{complex conjugate}$$

with

$$(7.63) \quad \lambda = \sqrt{\ell^2 + k^2}, \quad 0 < \ell < \infty, \quad k < \lambda < \infty.$$

As  $x \rightarrow \infty$ , the asymptotic behavior is given by the first term and its conjugate. Combined with (7.58), we have

$$(7.64) \quad \phi \sim \frac{1}{4} \left\{ \left( 1 + \frac{i\lambda}{\ell} \right) e^{i\ell x + ikx_2 - i\omega t} + \left( 1 - \frac{i\lambda}{\ell} \right) e^{-i\ell x + ikx_2 - i\omega t} \right\} e^{\lambda y}.$$

112

This represents an incoming oblique wave travelling in the direction  $(-\ell, k)$ , and its perfect reflection in the direction  $(\ell, k)$ . Perfect reflection and regularity at the shore go together as before.

---

<sup>1</sup>We use  $x$  rather than  $x_1$  for the offshore coordinate, since it is only  $x$  that appears after the separation (7.58).

Much earlier Stokes (1846) had found the basic edge wave solution

$$(7.65) \quad S = e^{-kx \cos \beta + ky \sin \beta}, \quad \lambda = \frac{\omega^2}{g} = k \sin \beta,$$

valid for all  $\beta$ .

Viewed as an eigenvalue problem for  $\lambda$ , (7.63) gives a continuous spectrum in  $k < \lambda < \infty$ , and (7.65) gives a discrete point in  $0 < \lambda < k$ . For  $\beta = \pi/4$ , there is in fact just the single point (7.65), and (7.64)-(7.65) give the complete spectrum.

In 1952, Peters [13] found an integral form of solution (extending (7.59)) for the continuous spectrum

$$(7.66) \quad k < \lambda < \infty,$$

and valid for general  $\beta$ . Also in 1952, Ursell found further edge wave solutions with discrete eigenvalues

$$(7.67) \quad \lambda = k \sin(2p + 1)\beta, \quad p = \text{integer},$$

provided

$$(2p + 1)\beta \leq \pi/2.$$

Thus for  $\pi/6 < \beta < \pi/2$ , there is just the Stokes edge wave (7.65) corresponding to  $p = 0$ . But as  $\beta$  drops below  $\pi/6$  a second one appears, as  $\beta$  drops below  $\pi/10$  a third one, and so on.

The relations between these two sets of solutions was not clear. It appears that Peters was only interested in oblique waves at infinity with  $\lambda > k$ , and Ursell only in edge waves with  $\lambda < k$ . Peters' approach was not used to obtain edge waves, and Ursell appears to have found the edge waves (which are sums of exponentials) by inspection and experience with other trapped modes, rather than by some procedure that could be tied to the other solutions. Peters' integral is quite difficult to use, and although Ursell's edge waves are sums of exponentials, the number increases as  $\beta \rightarrow 0$  and various asymptotics become difficult. 113

Here, we shall do the following which appears to be new.

- (1) Use a general Peters type approach, but for the case  $\beta = \pi/2N$ , and obtain an extension of (7.28) **both** for oblique incidence ( $k < \lambda < \infty$ ) and for edge waves ( $0 < \lambda < k$ ).

- (2) Show that in the edge wave case the final form can be freed from the restriction  $\beta = \pi/2N$ . These extensions of (7.28) can be used conveniently for various asymptotics, although details will not be given.

The unified derivation also gives confidence in the completeness of the solutions; this has been proved in detail for the case  $\beta = \pi/4$  by Minzoni [15].

We start from separated solutions of (7.59):

$$S = e^{px} \cdot e^{qy}, \quad p^2 + q^2 = k^2.$$

- 114 In order to keep a fairly symmetric form we might consider

$$p = k \cos h\chi, \quad q = \pm ik \sin h\chi,$$

or

$$p = k \cos \chi, \quad q = k \sin \chi,$$

rather than

$$q = \pm \sqrt{k^2 - p^2},$$

say. Both of the former are special cases of

$$(7.68) \quad p = \zeta + \frac{k^2}{4\zeta}, \quad q = \pm i \left( \zeta - \frac{k^2}{4\zeta} \right),$$

with  $\zeta = \frac{1}{2}e^\chi$  or  $\zeta = \frac{1}{2}e^{i\chi}$ ; (7.68) turns out to be most convenient of all. So we choose a superposition using this form and take

$$(7.69) \quad S(x, y) = \frac{1}{4\pi i} \int_{\mathcal{C}} f(\zeta) e^{\left(\zeta + \frac{k^2}{4\zeta}\right)x + i\left(\zeta - \frac{k^2}{4\zeta}\right)y} d\zeta \\ + \frac{1}{4\pi i} \int_{\mathcal{C}} g(\zeta) e^{\left(\zeta + \frac{k^2}{4\zeta}\right)x - i\left(\zeta - \frac{k^2}{4\zeta}\right)y} d\zeta,$$

as the generalization of (7.28) for  $k \neq 0$ . This satisfies the reduced Laplace equation (7.59). The bottom condition (7.61) requires

$$(7.70) \quad e^{-2i\beta} f(\zeta e^{2i\beta}) = g(\zeta).$$

just as before. (See (7.17)). An important condition on  $\mathcal{C}$  is again that, after a rotation  $\zeta' = \zeta e^{2i\beta}$ , the new contour  $\mathcal{C}'$  should be deformable back into  $\mathcal{C}$  without crossing any singularities. The top condition (7.60) gives

$$(7.71) \quad \left( \zeta - \frac{k^2}{4\zeta} + i\lambda \right) f(\zeta) = \left( \zeta - \frac{k^2}{4\zeta} - i\lambda \right) g(\zeta).$$

Combining (7.70) and (7.71), we have

$$(7.72) \quad f(\zeta) = w \frac{\zeta^2 - i\lambda\zeta - \frac{k^2}{4}}{\zeta^2 + i\lambda\zeta - \frac{k^2}{4}} f(w\zeta),$$

where  $w = e^{2i\beta}$ . We have a relation very similar to (7.18), but with **115** quadratic instead of linear factors.

If  $\beta = \pi/2N$ ,  $w^N = -1$ , the application of (7.72) successively,  $N$  times, relates  $f(\zeta)$  to  $f(-\zeta)$ , as before. Since the numerator and denominator differ by a sign change, we can read off a solution extending (7.24). We have

$$(7.73) \quad f(\zeta) = \frac{\zeta^{2N-1}}{Q_1(\zeta) \dots Q_N(\zeta)},$$

where

$$(7.74) \quad Q_n(\zeta) = \zeta^2 - i\lambda w^n \zeta - \frac{k^2}{4} w^{2n}, \quad w = e^{\pi i/N}.$$

The solution for  $S(x, y)$  is

$$(7.75) \quad \begin{aligned} S(x, y) &= \frac{1}{4\pi i} \int_{\mathcal{C}} \frac{\zeta^{2N-1} e^{\left(\zeta + \frac{k^2}{4\zeta}\right)x + i\left(\zeta - \frac{k^2}{4\zeta}\right)y}}{Q_1(\zeta) \dots Q_N(\zeta)} d\zeta \\ &= \frac{1}{4\pi i} \int_{\mathcal{C}} \frac{\zeta^{2N-1} e^{\left(\zeta + \frac{k^2}{4\zeta}\right)x - i\left(\zeta - \frac{k^2}{4\zeta}\right)y}}{Q_0(\zeta) \dots Q_{N-1}(\zeta)} d\zeta. \end{aligned}$$

### 7.6 Oblique incidence, $k < \lambda < \infty$

The difference between the two cases concerns the roots of the quadratics in (7.74). If  $k < \lambda < \infty$ , the roots are

$$(7.76) \quad \zeta = i \frac{\lambda + \ell}{2} e^{\pi i n / N}, \quad i \frac{\lambda - \ell}{2} e^{\pi i n / N},$$

where  $\ell = \sqrt{\lambda^2 - k^2}$ ; they lie on semicircles in  $\Re \zeta \leq 0$  as shown in Fig. 7.4. These points are poles in the integrals in (7.75); their residues have exponentials with  $\Re(\zeta + \frac{k^2}{4\zeta}) \leq 0$ , so that all of them

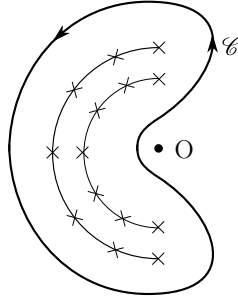

Figure 7.4:

are acceptable. Hence solutions can be obtained which are similar to the case  $k = 0$  but with double the number of terms. The solution for perfect reflection (regular at the shoreline) is obtained from the path  $\mathcal{C}$  chosen as in Fig. 7.4. This time there is an essential singularity at  $\zeta = 0$  which must be excluded, otherwise unacceptable solutions in positive powers of  $x$  and  $y$  would be obtained. This choice of  $\mathcal{C}$  satisfies the rotation requirement noted after equation (7.70). The rotation requirement excludes paths going between the poles on either semicircle, but an alternative is still to take a path enclosing only one or the other semicircle. However such choices give the same solution as the one shown, with an additional numerical factor.

When  $x = y = 0$ , the integrands in (7.75) are asymptotic to  $1/\zeta$  as



$\zeta \rightarrow \infty$ . Therefore

$$S(0,0) = 1$$

as before.

117

**Behavior as  $x \rightarrow \infty$ .**

The asymptotic behavior as  $x \rightarrow \infty$  is given by the four poles with  $\Re\zeta = 0$ , namely

$$(7.77) \quad \zeta = \pm i \frac{\lambda + \ell}{2}, \quad \zeta = \pm i \frac{\lambda - \ell}{2}.$$

We then have, after some simplification of the factors in the residues,

$$(7.78) \quad S(x,y) \sim \frac{1}{2CD} \left\{ \frac{1 + (-1)^N \rho^N}{1 - \rho} \right\} e^{i\ell x + \lambda y} + c.c.,$$

where

$$(7.79) \quad D = (1 - w)(1 - w^2) \dots (1 - w^{N-1}), \quad w = e^{\pi i/N},$$

$$(7.80) \quad C = (1 - \rho w)(1 - \rho^2) \dots (1 - \rho w^{N-1}), \quad \rho = \frac{\lambda - \ell}{\lambda + \ell}.$$

Combined with (7.58), we see that (7.78) represents the perfect reflection of an incoming oblique wave with direction  $(-\ell, k)$ .

The coefficient  $D$  arose in the case of normal incidence ( $\rho = 0$ ) and was found in (7.36) to be

$$(7.81) \quad D = N^{1/2} e^{-\pi i \frac{N-1}{4}}$$

We can find  $|C|$  by an argument similar to the one used for  $D$ . We consider

$$\begin{aligned} CC^* &= (1 - \rho w) \dots (1 - \rho w^{N-1}) (1 - \rho w^{-1}) \dots (1 - \rho w^{-(n-1)}) \\ &= \lim_{W \rightarrow 1} (W - \rho w) \dots (W - \rho w^{N-1}) (W - \rho w^{-1}) \dots (W - \rho w^{(N-1)}) \\ &= \lim_{W \rightarrow 1} \frac{W^{2N} - \rho^{2N}}{(W - \rho)(W + \rho)} \end{aligned}$$

$$(7.82) \quad = \frac{1 - \rho^{2N}}{1 - \rho^2}$$

118

There appears to be no simplified expression for  $\arg C$ . However, we have simplified the expression for the amplitude; (7.78) becomes

$$(7.83) \quad S(x, y) \sim \frac{1}{2N^{1/2}} \left\{ \frac{1 + (-1)^N \rho^N}{1 - (-1)^N \rho^N} \frac{1 + \rho}{1 - \rho} \right\}^{1/2} e^{i\ell x + \lambda y + i\alpha} + c.c.,$$

where

$$(7.84) \quad \alpha = -\arg C + \pi(N - 1)/4.$$

When  $\rho \rightarrow 1$ , there is a surprising difference in the behavior of the amplitude depending on whether  $N$  is odd or even. It is perhaps best viewed by renormalizing the solution so that the amplitude of the incoming wave is unity and the amplitude at the shoreline becomes

$$(7.85) \quad a_0 = N^{1/2} \left\{ \frac{1 - (-1)^N \rho^N}{1 + (-1)^N \rho^N} \frac{1 - \rho}{1 + \rho} \right\}^{1/2}.$$

When  $N$  is even  $a_0 \rightarrow 0$  as  $\rho \rightarrow 1$ , whereas it remains finite for  $N$  odd. However, in this limit  $C \rightarrow D$  so that

$$\alpha \rightarrow \pi(N - 1)/2.$$

When  $N$  is even,  $2\alpha$  is an odd multiple of  $\pi$  so the incoming and reflected wave are exactly out of phase in the limit and cancel. When  $N$  is odd,  $2\alpha$  is an even multiple of  $\pi$  so the incoming and reflected waves reinforce. Related to this is the fact (seen below) that when  $N$  is odd a new edge wave mode appears, and just when it appears the more usual exponential decay is absent.

**119** Nevertheless, the behavior is quite strange. For large values of  $N$  the corresponding changes in  $\beta$  are small and one would not expect rapid changes in behavior as  $N$  oscillates between odd and even values.

**Singular solutions**

As in the case of normal incidence, solutions with zero or partial reflection may be obtained by taking the path of integration in (7.75) to be similar to the paths  $\mathcal{C}_1, \mathcal{C}_2$  in Fig. (7.3). In this case, because of the essential singularity at  $\zeta = 0$ , they must go into the origin with  $\Re \zeta < 0$ .

**7.7 Edge waves,  $0 < \lambda < k$** 

For  $\lambda$  in the range  $(0, k)$ , if we set

$$(7.86) \quad \lambda = k \sin \mu, \quad 0 < \mu < \pi/2,$$

the roots of the quadratic in (7.74) are given by

$$(7.87) \quad (A) \quad \frac{k}{2} w^n e^{i\mu}, \quad (B) \quad -\frac{k}{2} w^n e^{-i\mu}.$$

These lie on two different semicircles of the **same** circle as indicated in Fig. 7.5.

Now these are poles of the integrals in (7.75). Those with  $\Re \zeta < 0$  would lead to exponentials with positive exponents in  $x$  and are unacceptable (since we require bounded solutions as  $x \rightarrow \infty$ ). Therefore, the contributions of the poles with  $\Re \zeta > 0$  must cancel between the two integrals in (7.75). This will only be possible for

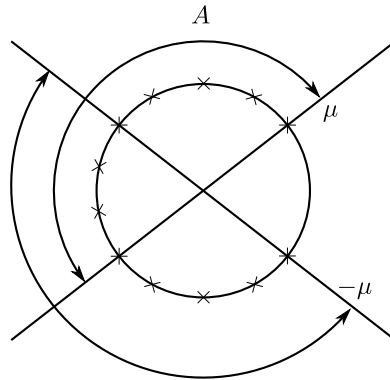

Figure 7.5:

certain values of  $\lambda$ , and leads to the restriction of  $\lambda$  to a discrete set of values: the point spectrum.

To carry out the details, we take the same contour  $\mathcal{C}$  as before, but deform it into the

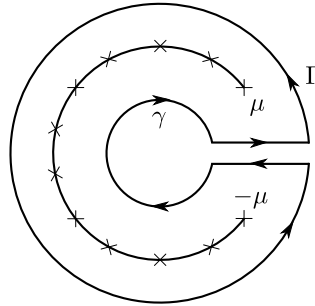

Figure 7.6:

two circles  $\Gamma$  and  $\gamma$  as shown in Fig. 7.6. Furthermore, the substitution of  $\zeta = k^2/4\xi$  in the integrals on  $\gamma$  converts them into integrals on  $\Gamma$ . When this is carried through, and pairs of integrals combined, we have

$$\begin{aligned}
 S(x, y) &= \frac{1}{4\pi i} \int_{\Gamma} \frac{\zeta^{N-1} \left\{ \zeta^N + \left( \frac{k^2}{4\zeta} \right)^N \right\}}{Q_1 \cdots Q_N} e^{\left( \zeta + \frac{k^2}{4\zeta} \right)x + i \left( \zeta - \frac{k^2}{4\zeta} \right)y} d\zeta \\
 (7.88) \quad &+ \frac{1}{4\pi i} \int_{\Gamma} \frac{\zeta^{N-1} \left\{ \zeta^N + \left( \frac{k^2}{4\zeta} \right)^N \right\}}{Q_0 \cdots Q_{N-1}} e^{\left( \zeta + \frac{k^2}{4\zeta} \right)x - i \left( \zeta - \frac{k^2}{4\zeta} \right)y} d\zeta.
 \end{aligned}$$

121 It should be especially noted that the final form fits with the original (7.69), but for a different function  $f(\zeta)$ . Thus there is a very important lack of uniqueness in the solution of the functional relation (7.72). However, the solutions for  $S(x, y)$  are the same; the change of  $f(\zeta)$  is compensated for by the change in contour from  $\mathcal{C}$  to  $\Gamma$ .

Now the requirement that poles with  $\Re \zeta > 0$  do not contribute is

easily obtained. The factor in the numerator of (7.88),

$$(7.89) \quad \zeta^N + \left(\frac{k^2}{4\zeta}\right)^N$$

vanishes at points

$$(7.90) \quad \zeta = \frac{k^2}{2} e^{\pi i \frac{2q+1}{2N}}, \quad q = \text{integer.}$$

These zeros are equally spaced around the circle in Fig.7.5, with angles  $\pi/N$  between them. If  $\mu$  is tuned so that these zeros lie on the poles there will be no singularities in the parts of  $A$  and  $B$  where  $A$  and  $B$  do not overlap, and this includes all those with  $\Re \zeta > 0$ . Where  $A$  and  $B$  do overlap, the double poles will be converted to single poles and provide non-zero contributions. Thus, the requirement is

$$(7.91) \quad \mu = \frac{2p+1}{2N} \pi$$

for some integer  $p$ . For  $\lambda$  in (7.86) we have

$$(7.92) \quad \lambda_p = k \sin(2p+1) \frac{\pi}{2N} = k \sin(2p+1)\beta.$$

where  $(2p+1)\beta < \pi/2$ . This is the result quoted in (7.67).

If we denote the modified  $f(\zeta)$  that appears in (7.88) by  $f_1(\zeta)$ , we have 122

$$f_1(\zeta) = \frac{\zeta^{2N} + \left(\frac{k^2}{4}\right)^N}{\zeta Q_1(\zeta) \cdots Q_N(\zeta)}.$$

For  $\lambda = \lambda_p$  as given in (7.91)-(7.92), the cancellation of appropriate factors can be carried through and we are left with

$$(7.93) \quad f_1(\zeta) = \frac{1}{\zeta} \frac{\zeta - \frac{k}{2} e^{-(2p-1)i\beta}}{\zeta + \frac{k}{2} e^{-(2p-1)i\beta}} \cdots \frac{\zeta - \frac{k}{2} e^{(2p+1)i\beta}}{\zeta + \frac{k}{2} e^{(2p+1)i\beta}}.$$

Here the relation  $\beta = \pi/2N$  has been used to eliminate  $N$  in favour of  $\beta$ . **In this form**, (7.93) is valid for any  $\beta$ , and is no longer limited to

submultiples of  $\pi/2$ . So the edge wave solutions  $S(x, y)$  can be extended to all  $\beta$  using (7.93). The first one,

$$(7.94) \quad \begin{aligned} p &= 0, \lambda_0 = k \sin \beta, \\ f_1(\zeta) &= \frac{1}{\zeta} \frac{\zeta - \frac{k}{2} e^{i\beta}}{\zeta + \frac{k}{2} e^{i\beta}}, \end{aligned}$$

leads to the Stokes solution (7.65).

As regards the direct strategy for finding (7.93) from (7.72), we note that (7.72), with  $\lambda = k \sin \mu$ , can be written

$$(7.95) \quad f_1(\zeta) = e^{2i\beta} \frac{\left(\zeta - \frac{k}{2} e^{i\mu}\right) \left(\zeta + \frac{k}{2} e^{-i\mu}\right)}{\left(\zeta + \frac{k}{2} e^{i\mu}\right) \left(\zeta - \frac{k}{2} e^{-i\mu}\right)} f_1\left(\zeta e^{2i\beta}\right).$$

**123** When  $\mu = (2p + 1)\beta$ , one would have to note how an appropriate number of iterations and some re-arrangement allows the solution to be picked off. For example, in the Stokes case  $\mu = \beta$ , (7.95) can be re-written

$$(7.96) \quad f_1(\zeta) = \frac{\zeta e^{2i\beta}}{\zeta} \left( \frac{\zeta - \frac{k}{2} e^{i\beta}}{\zeta + \frac{k}{2} e^{i\beta}} \right) \left( \frac{\zeta 2^{2i\beta} + \frac{k}{2} e^{i\beta}}{\zeta e^{2i\beta} - \frac{k}{2} e^{i\beta}} \right) f_1\left(\zeta e^{2i\beta}\right).$$

Then one checks that (7.94) is a solution. But this may not have been easy to see in advance, especially for higher  $p$ .

## Chapter 8

# Exact Solutions for Certain Nonlinear Equations

FOR THE WAVE problems of hyperbolic type studied in Chapters 1– 124  
3 we noted that the inclusion of dissipation would lead in the simplest case to Burgers' equation

$$(8.1) \quad \eta_t + \eta\eta_x = \eta_{xx}.$$

We also noted the remarkable fact that this equation could be transformed into the heat equation

$$(8.2) \quad v_t - v_{xx} = 0$$

by the substitution

$$(8.3) \quad \eta = -2(\log v)_x = -\frac{2v_x}{v}.$$

Thomas's equation

$$(8.4) \quad u_{xy} + pu_x + qu_y + u_xu_y = 0$$

could be made linear by a similar transformation:

$$u = \log v.$$

In the water wave context, when dispersion rather than dissipation is incorporated, the simplest basic equation is the Korteweg-de Vries equation

$$(8.5) \quad \eta_t + \eta\eta_x + \eta_{xxx} = 0.$$

The derivation of the equation and its background are described in [1], Sections 13.11–13.13. In recent years, a remarkable number of developments have led to unusual and quite intricate methods of finding solutions to (8.5). These in turn have led to similar developments for the following equations.

$$(8.6) \quad \text{Modified KdV} \quad u_t + 3u^2u_x + u_{xxx} = 0,$$

$$(8.7) \quad \text{Sine-Gordon} \quad u_{tt} - u_{xx} + \sin u = 0,$$

$$(8.8) \quad \text{Cubic Schrodinger} \quad iu_t + u_{xx} + |u|^2u = 0,$$

$$(8.9) \quad \text{Boussinesq} \quad u_{tt} - u_{xx} - (u^2)_{xx} - u_{xxx} = 0.$$

## 8.1 Solitary waves

In their original paper [16] published in 1895, Korteweg-de Vries found special solutions of (8.5) in the form of steady profile waves moving with constant velocity. These may be obtained by taking

$$(8.10) \quad \eta = \eta(X), \quad X = x - \alpha^2 t,$$

where  $\alpha^2$  is the constant velocity of translation. We have

$$\eta_{XXX} + \eta\eta_X - \alpha^2\eta_X = 0,$$

and after two integrations

$$(8.11) \quad \frac{1}{2}\eta_X^2 + \frac{1}{6}\eta^3 - \frac{1}{2}\alpha^2\eta^2 + A\eta + B = 0,$$

where  $A, B$  are constants of integration. In general (8.11) has solutions in periodic elliptic functions ('cnoidal waves'), so that (8.10) represents



a moving wave train. In the special case  $A = B = 0$  (which corresponds to the limit  $cn^2 \rightarrow \sec h^2$  in the elliptic functions) we have

$$(8.12) \quad \eta_X^2 = \frac{1}{3}\eta^2(3\alpha^2 - \eta),$$

with solution

$$(8.13) \quad \eta = 3\alpha^2 \sec h^2 \frac{1}{2}(\alpha x - \alpha^3 t).$$

This is the ‘solitary wave’ consisting of a single hump. It should be noted that the velocity  $\alpha^2$  is related to the height  $3\alpha^2$ ; stronger waves move faster. 126

Similar solutions can be obtained for (8.6)-(8.9).

However, the big advance came with the discovery of more general solutions for (8.5), and in particular solutions for the interaction of solitary waves, by Gardner, Greene, Kruskal, Muir [17] in 1967. The formula for the interaction of  $N$  solitary waves is

$$(8.14) \quad \eta = 12 \frac{\partial^2}{\partial x^2} \log |D|,$$

where  $|D|$  is the  $N \times N$  determinant with elements

$$(8.15) \quad D_{mn} = \delta_{mn} + \frac{2\gamma_m}{\alpha_m + \alpha_n} e^{-\alpha_m x + \alpha_m^3 t}.$$

Each parameter  $\alpha_m$  corresponds to one of the solitary waves (8.13); in the case  $N = 1$ ,  $\gamma_1 = \alpha_1$  (8.14)-(8.15) reduces to (8.13). The parameters  $\gamma_m$  play the minor role of spacing the original positions of the solitary waves. The form of the solution (8.14) is sufficiently unusual and complicated to indicate that a whole new set of ideas and techniques is involved. Even the thought of verifying (8.14) by direct substitution is alarming since five derivatives of  $|D|$  would be required!

Physically the result is also interesting since it shows that after interaction each solitary wave emerges with its original shape and velocity. 127

Similar results were eventually found for the equations in (8.6)-(8.9). As another illustration of the novelty of these solutions it may

be noted that (8.6) has a solution

$$u = 2\sqrt{2} \frac{\partial}{\partial x} \tan^{-1} \left\{ \frac{\alpha}{k} \sec h(\alpha x - \beta t) \sin(kx - \omega t) \right\}$$

$$\frac{\omega}{k} = -k^2 + 3\alpha^2, \quad \frac{\beta}{\alpha} = -3k^2 + \alpha^2.$$

This represents a ‘wave packet’ with oscillations moving through an envelope of solitary shape.

The original methods are reviewed in [1], Chapter 17. Here an alternative recent method will be described.

## 8.2 Perturbation approaches

So much of the progress on nonlinear problems in all fields has been made by perturbation methods that we wondered what the story was here. Could the above solutions be obtained by relatively simple perturbation approaches, even if we have to rely on the existing results to stimulate the correct procedures? Secondly, having learnt the correct procedures, is there hope of applying these methods **in approximate form** in cases where it seems most unlikely that exact solutions could be expected? The first question does lead to an interesting and rather simple way of finding the solutions, with information of general value for perturbation theory. It also gives a new view on what these special equations have in common. The second question is still more open; as we shall see certain features of the equation must be just right to make progress.

This programme was carried through by R. Rosales and his account will appear in Ref. [18].

We start with Burgers’ equation, since a nice feature is that these earlier cases can be included and contrasted with the later ones.

## 8.3 Burgers’ and Thomas’s equations

We shall establish all the ideas and notation on this case so the account may appear long for a ‘simple’ method.

We write the equation as

$$(8.16) \quad \eta_t - \eta_{xx} = -\eta\eta_x,$$

and we begin with an expansion in terms of a small parameter  $\epsilon$  in the form

$$(8.17) \quad \eta = \sum_1^{\infty} \epsilon^n \eta^{(n)}(x, t).$$

After substitution we read off the usual hierarchy

$$(8.18) \quad \eta_t^{(1)} - \eta_{xx}^{(1)} = 0,$$

$$(8.19) \quad \eta_t^{(n)} - \eta_{xx}^{(n)} = - \sum_{j=1}^{n-1} \eta^{(j)} \eta_x^{(n-j)},$$

to be solved successively. At each stage the right side of (8.19) is known so that only the solution of the inhomogeneous heat equation is ever involved.

Of course, experience suggests that such a simple approach will **129** prove inadequate in some way, and the art of perturbation approaches is in learning how to correct the deficiencies.

The difficulty in this case is easily seen by considering the shock wave solution of (8.16). This solution is the counterpart of (8.13) and is found in similar fashion. It may be written

$$(8.20) \quad \eta = \frac{e^{-\alpha x + \alpha^2 t}}{1 + \frac{\epsilon}{2\alpha} e^{\alpha x + \alpha^2 t}}$$

where a parameter  $\epsilon$  has been include to compare with (8.17). If (8.20) is formally expanded in a power series in  $\epsilon$ , we have

$$(8.21) \quad \eta = \epsilon e^{-\alpha x + \alpha^2 t} - \frac{\epsilon^2}{2\alpha} e^{-2\alpha x + 2\alpha^2 t} + \dots$$

It may be verified that this is the solution of (8.19) starting from the special case

$$\eta^{(1)} = e^{-\alpha x + \alpha^2 t}.$$

We immediately see the limitation on (8.21); it converges only for

$$\left| \epsilon e^{-\alpha x + \alpha^2 t} \right| < 1,$$

i.e. for sufficiently large  $x$ . But we also see that the  $\epsilon$  is spurious. It could be absorbed by replacing  $x$  by

$$x - \frac{1}{\alpha} \log \epsilon.$$

Since this is a trivial change in origin, the  $\epsilon$  plays no real role. It serves only to suggest the ordering of terms in (8.19). We may set  $\epsilon = 1$ . The real issue is to sum the series (8.21) in the form (8.20), so that the perturbation series valid only for sufficiently large  $x$  is extended to be  
**130** valid for all  $x$ . This is like finding an analytic continuation. In this particular case we need only sum

$$z - z^2 + z^3 - \dots$$

as

$$\frac{z}{1+z},$$

and we have the exact solution.

We now examine the general case starting with  $\eta^{(1)}$  as the general solution of the heat equation (8.18). Although we are not usually interested in real exponential solutions of linear equations (since they are unbounded), we see from (8.20) and (8.21) that they are crucially important in the present context; the final form in (8.20) is bounded. Indeed one important case would be

$$(8.22) \quad \eta^{(1)}(x, t) = \sum_{j=1}^N a_j e^{-\kappa_j x + \kappa_j^2 t};$$

this would lead to the interaction of shocks. But we are also interested in the usual Fourier integral solution

$$(8.23) \quad \eta^{(1)}(x, t) = \int_{-\infty}^{\infty} e^{ikx - k^2 t} F(k) dk.$$

To include both and to avoid the display of too many summations as in (8.22), we use the notation

$$(8.24) \quad \eta^{(1)}(x, t) = \int e^{-\alpha x + \alpha^2 t} d\lambda(\alpha).$$

This should not conjure up worries of any deep measure theory. It merely means sum over any distribution of  $\alpha$  with appropriate weights. In (8.22) the sum is over

$$(8.25) \quad \alpha = \kappa_1, \kappa_2, \dots, \kappa_N,$$

with weights

$$(8.26) \quad a_1, a_2, \dots, a_N;$$

in (8.23) the sum is over  $-i\infty < \alpha < i\infty$ , with  $\alpha = ik$  and weighting function  $F(k) dk$ . The general form would include both. We shall further write (8.24) as 131

$$(8.27) \quad \eta^{(1)} = \int e^{\Omega} d\lambda(\alpha),$$

where

$$(8.28) \quad \Omega = -\alpha x + \alpha^2 t,$$

and after a while drop the  $d\lambda$  altogether.

For the successive equations for the  $\eta^{(n)}(x, t)$ , it is clear that one may take solutions in the form of  $n$ -fold integrals

$$(8.29) \quad \eta^{(n)}(x, t) = \int \dots \int \phi^{(n)}(\alpha_1, \dots, \alpha_n) e^{\Omega_1 + \dots + \Omega_n} d\lambda(\alpha_1) \dots d\lambda(\alpha_n),$$

where each  $\Omega_j$  has the corresponding  $\alpha_j$ . For example,

$$\begin{aligned} \eta_t^{(2)} - \eta_{xx}^{(2)} &= -\eta^{(1)} \eta_x^{(1)} \\ &= + \int \int \alpha_2 e^{\Omega_1 + \Omega_2} d\lambda(\alpha_1) d\lambda(\alpha_2), \end{aligned}$$

using the dummy variable  $\alpha_1$  for the first factor  $\eta^{(1)}$  and dummy variable  $\alpha_2$  in the second factor  $\eta_x^{(1)}$ . Then, using (8.29) with  $n = 2$ , we have

$$(8.31) \quad \{\alpha_1^2 + \alpha_2^2 - (\alpha_1 + \alpha_2)^2\} \phi^{(2)} = \alpha_2.$$

132 Therefore,

$$(8.32) \quad \phi^{(2)} = -\frac{1}{2\alpha_1}.$$

For  $\eta^{(3)}$ , we have

$$(8.33) \quad \begin{aligned} \eta_t^{(3)} - \eta_{xx}^{(3)} &= -\eta^{(1)}\eta_x^{(2)} - \eta^{(2)}\eta_x^{(1)} \\ &= -\int \int \int \left\{ \frac{\alpha_2 + \alpha_3}{2\alpha_2} + \frac{\alpha_3}{2\alpha_1} \right\} e^{\Omega_1 + \Omega_2 + \Omega_3} d\lambda_1 d\lambda_2 d\lambda_3. \end{aligned}$$

In the first pair,  $\alpha_1$  is used for  $\eta^{(1)}$ , and  $\alpha_2, \alpha_3$  are used in  $\eta_x^{(2)}$ . In the second pair,  $(\alpha_1, \alpha_2)$  are used in  $\eta^{(2)}$ , and  $\alpha_3$  in  $\eta_x^{(1)}$ . This preservation of symmetry in the right hand side is important. Now, using (8.29) with  $n = 3$ , we have

$$(8.34) \quad \{\alpha_1^2 + \alpha_2^2 + \alpha_3^2 - (\alpha_1 + \alpha_2 + \alpha_3)^2\} \phi^{(3)} = -\frac{\alpha_1\alpha_2 + \alpha_1\alpha_3 + \alpha_2\alpha_3}{2\alpha_1\alpha_2}.$$

Therefore,

$$(8.35) \quad \phi^{(3)} = \frac{1}{2^2\alpha_1\alpha_2}.$$

At this stage, or after one more iteration, one can compare (8.27), (8.32), (8.35) and suggest the general form

$$(8.36) \quad \phi^{(n)}(\alpha_1, \dots, \alpha_n) = \frac{(-1)^{n-1}}{2^{n-1}\alpha_1 \cdots \alpha_{n-1}}.$$

Accepting this for the present, the series solution is

$$(8.37) \quad \eta(x, t) = \sum_1^{\infty} \frac{(-1)^{n-1}}{2^{n-1}} \int \cdots \int \frac{e^{\Omega_1 + \cdots + \Omega_n}}{\alpha_1\alpha_2 \cdots \alpha_{n-1}} d\lambda(\alpha_1) \cdots d\lambda(\alpha_n).$$

133 Now this series solution is the general counterpart to (8.21) and is limited in the same way: it will only be valid for sufficiently large  $x$ . The crux of the matter is whether it can be summed to give a uniformly valid solution for all  $x$ . But we see that it can. The multiple integral is in fact a product of integrals. If we define

$$(8.38) \quad B(x, t) = \int \frac{1}{2} e^{\Omega} d\lambda(\alpha), \quad \text{satisfying} \quad B_t - B_{xx} = 0,$$

then

$$(8.39) \quad \eta(x, t) = -2 \sum_1^{\infty} (-1)^{n-1} B^{n-1} B_x.$$

We have the same simple series as before and it is immediately summed to give

$$(8.40) \quad \eta = -2 \frac{B_x}{1+B} = -2 \{\log(1+B)\}_x.$$

Equation (8.38) and (8.40) provide exactly the Cole-Hopf transformation (8.3) with  $v = 1+B$ ! We believe this is the first derivation of the Cole-Hopf transformation.

In the case of Thomas's equation (8.4), the perturbation series is found to be

$$(8.41) \quad u = \sum_1^{\infty} \frac{(-1)^{n-1}}{n} \int \dots \int e^{\Omega_1 + \dots + \Omega_n} d\lambda(\alpha_1) \dots d\lambda(\alpha_n),$$

this time with

$$(8.42) \quad \left. \begin{aligned} \Omega &= \alpha x + \beta y \\ \alpha\beta + p\alpha + q\beta &= 0, \end{aligned} \right\}$$

to fit the different linear part. Thus, with

$$(8.43) \quad B(x, t) = \int e^{\Omega} d\lambda(\alpha),$$

we have

134

$$u = \sum_1^{\infty} \frac{(-1)^{n-1}}{n} \\ = \log(1 + B).$$

And, from (8.43) and (8.42),  $B$  satisfies

$$(8.44) \quad B_{xy} + pB_x + qB_y = 0.$$

This is Thomas's transformation.

We observe the two key features in both cases: (1)  $\eta^{(n)}$  factors into a product, and (2) the resulting series is easily summed.

Detailed verification of (8.36) will not be given, since it has clearly led to the correct results. We prefer to leave the detailed study to the corresponding steps in the more interesting case of the KdV equation. It should also be stressed that the success of the method is in spotting the form of the  $\phi^{(n)}$  after the first few values have been found. Once the general form is strongly indicated, its proof depends on proving an algebraic identity among the  $\alpha_1, \dots, \alpha_n$ , and is standard (if not always obvious). Thus, it is more important to add a few further remarks on deducing (8.35) than on proving the general form.

The common factor

$$\alpha_1\alpha_2 + \alpha_1\alpha_3 + \alpha_2\alpha_3$$

135 is cancelled through in (8.34) because the symmetry on the right of (8.33) was carefully preserved. To illustrate what is involved, suppose the parameter  $\alpha_1$  is used for  $\eta^{(1)}$  and parameters  $(\alpha_2, \alpha_3)$  in  $\eta^{(2)}$  for both terms. Then we should have

$$\frac{\alpha_2 + \alpha_3 + \alpha_1}{2\alpha_2}$$

as the factor on the right. One then has to spot that

$$\frac{\alpha_1\alpha_2 + \alpha_1\alpha_3 + \alpha_2\alpha_3}{2\alpha_1\alpha_2} = \frac{1}{2} + \frac{\alpha_3}{2\alpha_2} + \frac{\alpha_3}{2\alpha_1}$$

is an equivalent form under the triple integrals, since the  $\alpha'$ s are just dummy variables and  $\alpha_3/2\alpha_1$  can be relabelled  $\alpha_1/2\alpha_2$ .



## 8.4 Korteweg-de Vries equation

It simplifies things, but is not essential, to introduce  $\eta = -12\psi_x$ , integrate once with respect to  $x$ , and work with

$$(8.45) \quad \psi_t + \psi_{xxx} = 6\psi_x^2,$$

a form that has often been used for other purposes. (The factor 6 is pure convenience to avoid powers of 6 appearing in later expressions).

The perturbation series is

$$(8.46) \quad \begin{aligned} \psi &= \sum_1^{\infty} \psi^{(n)}. \\ \psi_t^{(n)} + \psi_{xxx}^{(n)} &= 6 \sum_{j=1}^{n-1} \psi_x^{(j)} \psi_x^{(n-j)}. \end{aligned}$$

To see the nature of the problem one might again check the situation for the simplest solution, namely the single solitary wave (8.13). If we start with

$$\psi^{(1)} = e^{-\alpha x + \alpha^3 t} = \alpha P, \quad \text{say,}$$

it is easily found that the series (8.46) is

$$\psi = \alpha \sum_1^{\infty} (-1)^{n-1} P^n.$$

The validity is originally limited by convergence, but is immediately summed to

$$(8.47) \quad \psi = \frac{\alpha P}{1+P} = -\frac{P_x}{1+P} = -\frac{\partial}{\partial x} \log(1+P).$$

This is (8.13) written in terms of  $\psi$ . The issue is again to sum the series to obtain a solution valid for all  $x$ . Again the series is no more than  $(1+P)^{-1}$ .

For the general solution we start with

$$(8.48) \quad \psi^{(1)} = \int e^{\Omega} d\lambda(\alpha), \quad \Omega = -\alpha x + \alpha^3 t,$$

which in our notation is the general solution of the linear equation

$$(8.49) \quad \psi_t^{(1)} + \psi_{xxx}^{(1)} = 0.$$

The change from (8.27)-(8.28) is only in the  $\Omega$ . The expression for  $\psi^{(n)}$  will be an  $n$ -integral (8.29) as before. The detailed derivation of the coefficient  $\phi^{(n)}(\alpha_1, \dots, \alpha_n)$  is given later so that we can immediately focus on the method and the contrast with the Burgers' and Thomas's cases. The perturbation series is found to be

$$(8.50) \quad \psi = \sum_{n=1}^{\infty} (-1)^{n-1} 2^{n-1} \int \dots \int \frac{e^{-\alpha_1 x + \alpha_1^3 t} e^{-\alpha_2 x + \alpha_2^3 t} \dots e^{-\alpha_n x + \alpha_n^3 t}}{(\alpha_1 + \alpha_2) (\alpha_2 + \alpha_3) \dots (\alpha_{n-1} + \alpha_n)},$$

137 and the  $d\lambda(\alpha_1) d\lambda(\alpha_2) \dots d\lambda(\alpha_n)$  is not displayed in this already long expression. In this case the  $n$ -fold integral does not split into a product, but the successive integrals are only linked pairwise through the factors  $(\alpha_j + \alpha_{j+1})$  in the denominator. It is the second class in the order of complexity. Burgers' and Thomas's cases have complete factorization; the coefficient  $\phi^{(n)}$  takes the form  $f(\alpha_1)f(\alpha_2)\dots f(\alpha_n)$ , although with very simple cases  $f \propto 1/\alpha, f \propto 1$ . In (8.50) we have the next class where the factorization is pairwise.

$$(8.51) \quad f(\alpha_1, \alpha_2) f(\alpha_2, \alpha_3) \dots f(\alpha_{n-1}, \alpha_n),$$

again with very simple  $f$ .

To bring out the pairwise linkage more strongly, we may incorporate the exponentials into the scheme by splitting

$$e^{-\alpha_j x + \alpha_j^3 t}$$

into

$$e^{-\frac{1}{2}\alpha_j x + \frac{1}{2}\alpha_j^3 t} \cdot e^{-\frac{1}{2}\alpha_j x + \frac{1}{2}\alpha_j^3 t}$$

and combining the first with  $j - 1$  and the second with  $j + 1$ . Part will be left over at beginning and end, but we may write

$$(8.52) \quad \psi = \sum_{n=1}^{\infty} (-1)^{n-1} p(\alpha_1) P(\alpha_1, \alpha_2) P(\alpha_2, \alpha_3) \dots P(\alpha_{n-1}, \alpha_n) P(\alpha_n),$$

where

$$(8.53) \quad \begin{aligned} p(\alpha) &= e^{-\frac{1}{2}\alpha x + \frac{1}{2}\alpha^3 t}, \\ P(\alpha, \beta) &= 2 \frac{e^{-\frac{1}{2}\alpha x + \frac{1}{2}\alpha^3 t} \cdot e^{-\frac{1}{2}\beta x + \frac{1}{2}\beta^3 t}}{\alpha + \beta} \end{aligned}$$

$$(8.54) \quad \text{i.e. } P(\alpha, \beta) = \frac{2p(\alpha)p(\beta)}{\alpha + \beta}$$

$$(8.55) \quad \frac{\partial p}{\partial x}(\alpha, \beta) = -p(\alpha)p(\beta),$$

and we use a

138

### Summation Convention:

Repeated  $\alpha$ 's are to be integrated  $\int d\lambda(\alpha)$ .

## 8.5 Discrete set of $\alpha$ 's interacting solitary waves

We now consider the special case (8.25)-(8.26) where the  $\alpha$ 's range over a discrete set

$$\alpha = \kappa_1, \kappa_2, \dots, \kappa_N,$$

and the integrals are in fact sums. Then each  $\alpha_m$  ranges over

$$(8.56) \quad \alpha_m = \kappa_{i_m}, i_m = 1, \dots, N.$$

If we let

$$(8.57) \quad \begin{aligned} p_i &= a_i e^{-\frac{1}{2}\kappa_i x + \frac{1}{2}\kappa_i^3 t} \\ P_{ij} &= 2a_i a_j \frac{e^{-\frac{1}{2}\kappa_i x + \frac{1}{2}\kappa_i^3 t} \cdot e^{-\frac{1}{2}\kappa_j x + \frac{1}{2}\kappa_j^3 t}}{\kappa_i + \kappa_j} \end{aligned}$$

$$(8.58) \quad = 2 \frac{p_i p_j}{\kappa_i + \kappa_j},$$

then (8.52) may be written

$$(8.59) \quad \psi = \sum_1^{\infty} (-1)^{n-1} p_{i_1 i_2} P_{i_1 i_2} P_{i_1 i_2} \cdots P_{i_{n-1} i_n} P_{i_n},$$

where each  $i_m$  is summed over  $1, \dots, N$ , according to (8.56). But this summation convention is now the usual one and (8.59) involves just ordinary matrix products. In matrix form, (8.59) is written

$$(8.60) \quad \psi = \sum_1^{\infty} (-1)^{n-1} p^T P^{n-1} p,$$

**139** where  $p^T$  is the transpose (row vector) of the column vector  $p$ . Now, the crucial step is to sum (8.60) in the matrix form

$$(8.61) \quad \psi = p^T (1 + P)^{-1} p,$$

in order to extend the validity to all  $x$ . This is an acceptable form, but it can also be manipulated into a more convenient one. First

$$\begin{aligned} p^T A p &= p_i A_{ij} p_j = A_{ij} p_j p_i \\ &= \text{Trace } A p p^T; \end{aligned}$$

Therefore

$$\psi = \text{Trace } \left\{ (1 + P)^{-1} p p^T \right\}.$$

Then, from (8.55) or (8.57)-(8.58),

$$p p^T = -\frac{\partial P}{\partial x};$$

therefore

$$\begin{aligned} \psi &= \text{Tr} \left\{ -(1 + P)^{-1} P_x \right\} \\ &= -\frac{\partial}{\partial x} \text{Tr} \{ \log(1 + P) \}. \end{aligned}$$

Finally for any matrix  $A$

$$\text{Tr} \log A = \log \det |A|;$$

this is trivially true for a diagonal matrix and any symmetric matrix can be made diagonal by a similarity transformation. Therefore

$$(8.61) \quad \psi = -\frac{\partial}{\partial x} \log \det |1 + P|.$$

With  $\eta = -12\psi_x$ , this is (8.14).

## 8.6 Continuous range; Marcenko integral equation

140

In the case when  $\alpha$  has a continuous range over  $-i\infty$  to  $i\infty$ , i.e. we start with a Fourier integral in (8.48), then formally at least (8.52) could still be written

$$\psi = \sum_{n=1}^{\infty} (-1)^{n-1} p(\alpha) P^{n-1}(\alpha, \beta) p(\beta),$$

with the understanding that powers and products have to be interpreted with the summation  $\int d\lambda$ . If we define

$$(8.62) \quad (1 + P)^{-1} = \sum_{n=1}^{\infty} (-1)^{n-1} P^{n-1},$$

then formally

$$\psi = p^T (1 + P)^{-1} p,$$

but any practical use would require some interpretation of the operator  $(1 + P)^{-1}$  other than the series in (8.62). There seems to be no immediate analogue of (8.61).

In fact explicit solutions corresponding to this case have not been found by any method. However, the problem can be reduced to a linear integral equation, which is useful for various questions, such as asymptotics for  $t \rightarrow \infty$ . This can be found most easily from (8.50) by writing the terms as products in a different way.

In Fourier integrals it is natural to associate additional factors in  $\alpha$  with operations with respect to  $x$ . For example if

$$(8.63) \quad B(x) = \int e^{-\alpha x + \alpha^3 t} d\lambda(\alpha),$$

then

$$\int_x^\infty B(z) dz = \int \frac{1}{\alpha} e^{-\alpha x + \alpha^3 t} d\lambda(\alpha).$$

141

But in (8.50), we have the pairwise linkage to contend with. However, if the exponentials are split into two halves, as before, and the integration performed on the successive pairs

$$e^{-\frac{1}{2}(\alpha_j + \alpha_{j+1})x},$$

we obtain the required factors. This leads to

$$\psi = \sum_1^\infty (-1)^{n-1} \int_x^\infty \dots \int_x^\infty B\left(\frac{x+z_1}{2}\right) B\left(\frac{z_1+z_2}{2}\right) \dots B\left(\frac{z_{n-1}+x}{2}\right) dz_1 \dots dz_{n-1}, \quad (8.64)$$

where  $B(x)$  is given by (8.63). (The dependence of  $B$  on  $t$  is not displayed).

Now (8.64) is another type of product. To bring this out, we must define multiplication in some way as “multiplication by  $B$  and integration  $\int_x^\infty$ ”. First in order to keep clear the different arguments of  $B$  in (8.64), we temporarily write  $B(\frac{x+y}{2})$  as  $B(x, y)$ . Then to introduce the appropriate multiplication we define the operator  $\hat{B}$  acting on functions  $f(x, y)$  by

$$\hat{B}f(x, y) = \int_x^\infty f(x, y) B(z, y) dz. \quad (8.65)$$

Then (8.64) may be written

$$\psi = \left[ \sum_{n=1}^\infty (-1)^{n-1} \hat{B}^{n-1} B(x, y) \right]_{y=x}. \quad (8.66)$$

142

Notice that two space-like variables come in automatically in this

view, and<sup>1</sup>

$$\psi(x) = K(x, x)$$

where

$$(8.67) \quad K(x, y) = \sum_1^{\infty} (-1)^{n-1} \hat{B}^{n-1} B(x, y).$$

The appearance of the extra dimension is a crucial step; in the original inverse scattering methods it arises due to the associated scattering problem. Here it arises in writing (8.64) precisely as a product.

Formally, we would sum (8.67) as

$$(8.68) \quad K(x, y) = (I + \hat{B})^{-1} B(x, y).$$

Then, again, practical use would require interpretations of the operator  $(I + \hat{B})^{-1}$  other than by the series. However it would follow from (8.68) by applying  $I + \hat{B}$  to both sides that

$$(8.69) \quad (I + \hat{B})K(x, y) = B(x, y).$$

This can be justified (avoiding use of (8.68) and the definition of  $(I + \hat{B})^{-1}$ ) by applying the well-defined operator  $I + \hat{B}$  directly to (8.67); the only assumption is that (8.67) converges for sufficiently large  $x$ . From the definition of  $\hat{B}$ , (8.69) is

$$(8.70) \quad K(x, y) + \int_x^{\infty} K(x, z)B(z, y) dz = B(x, y).$$

This is the Marcenko integral equation. So the final prescription is **143** to take a general solution (8.63) of the linear equation

$$B_t + B_{xxx} = 0,$$

solve (8.70) for  $K(x, y, t)$ , then

$$\psi(x, t) = K(x, x, t).$$

---

<sup>1</sup>The  $t$ -dependence is suppressed throughout these manipulations, so that  $K$ , like  $B$ , is in fact a function of  $x, y, t$ .

### 8.7 The series solution

The derivation of the terms in (8.50) is now given in detail, since by this approach everything depends on the factored (pairwise) form. As explained in connection with Burgers' equation, we have

$$(8.71) \quad \psi^{(n)}(x, t) = \int \dots \int \phi^{(n)}(\alpha_1, \dots, \alpha_n) e^{\Omega_1 + \dots + \Omega_n} d\lambda_1 \dots d\lambda_n$$

where

$$\Omega_m = -\alpha_m x + \alpha_m^3 t.$$

The equation for  $\psi^{(2)}$  is

$$\psi_t^{(2)} + \psi_{xxx}^{(2)} = 6\psi_x^{(1)}\psi_x^{(1)};$$

hence

$$(8.72) \quad \{\alpha_1^3 + \alpha_2^3 - (\alpha_1 + \alpha_2)^3\} \phi^{(2)} = 6\alpha_1\alpha_2,$$

and we have

$$(8.73) \quad \phi^{(2)} = -\frac{2}{\alpha_1 + \alpha_2}$$

The equation for  $\psi^{(3)}$  is

$$\psi_t^{(3)} + \psi_{xxx}^{(3)} = 6\psi_x^{(1)}\psi_x^{(2)} + 6\psi_x^{(2)}\psi_x^{(1)};$$

144 hence

$$(8.74) \quad \{\alpha_1^3 + \alpha_2^3 + \alpha_3^3 - (\alpha_1 + \alpha_2 + \alpha_3)^3\} \phi^{(3)} = 6\{2\alpha_1 + 2\alpha_3\}.$$

The factor on the left simplifies to

$$-3(\alpha_2 + \alpha_3)(\alpha_3 + \alpha_1)(\alpha_1 + \alpha_2),$$

and we have

$$(8.75) \quad \phi^{(3)} = \frac{2^2}{(\alpha_1 + \alpha_2)(\alpha_2 + \alpha_3)}$$



It is, surely, now reasonable to propose

$$(8.76) \quad \phi^{(n)} = \frac{(-1)^{n-1} 2^{n-1}}{(\alpha_1 + \alpha_2) \dots (\alpha_{n-1} + \alpha_n)}, \quad n > 1.$$

On substitution in

$$\psi_t^{(n)} + \psi_{xxx}^{(n)} = 6 \sum_{j=1}^{n-1} \psi_x^{(j)} \psi_x^{(n-j)}, \quad n > 1,$$

we have

$$\begin{aligned} & \{\alpha_1^3 + \dots + \alpha_n^3 - (\alpha_1 + \dots + \alpha_n)^3\} \phi^{(n)} \\ &= 3(-1)^n 2^{n-1} \sum_{j=1}^{n-1} \frac{(\alpha_1 + \dots + \alpha_j)}{(\alpha_1 + \alpha_2) \dots (\alpha_{j-1} + \alpha_j)} \times \\ & \quad \frac{(\alpha_{j+1} + \dots + \alpha_n)}{(\alpha_{j+1} + \alpha_{j+2}) \dots (\alpha_{n-1} + \alpha_n)} \end{aligned}$$

Thus, to prove (8.76), we need to show that

$$(8.77) \quad \begin{aligned} & (\alpha_1 + \dots + \alpha_n)^3 - (\alpha_1^3 + \dots + \alpha_n^3) \\ &= 3 \sum_{j=1}^{n-1} (\alpha_1 + \dots + \alpha_j) (\alpha_j + \alpha_{j+1}) (\alpha_{j+1} + \dots + \alpha_n) \end{aligned}$$

The sum on the right hand side is equal to

$$\begin{aligned} & \sum (\alpha_1 + \dots + \alpha_{j-1}) \alpha_j (\alpha_{j+1} + \dots + \alpha_n) \\ & \quad + \sum \alpha_j^2 (\alpha_{j+1} + \dots + \alpha_n) \\ & + \sum (\alpha_1 + \dots + \alpha_j) \alpha_{j+1} (\alpha_{j+2} + \dots + \alpha_n) \\ & + \sum (\alpha_1 + \dots + \alpha_j) \alpha_{j+1}^2 \\ & = 2 \sum_{k>\ell>m} \alpha_k \alpha_\ell \alpha_m + \sum_{k \neq \ell} \alpha_k^2 \alpha_\ell. \end{aligned}$$

145

The expression on the left of (8.77) is 3 times this, so the result follows.

## 8.8 Other equations

The series approach goes through in a similar way for the other equations noted in (8.6)-(8.9). A common feature is that the  $n$ th term always displays the pairwise linking in the integral noted in (8.51), and takes the form

$$(8.88) \quad \int \dots \int f(\alpha_1, \alpha_2) \dots f(\alpha_{n-1}, \alpha_n) e^{\Omega_1 + \dots + \Omega_n} d\lambda(\alpha_1) \dots d\lambda(\alpha_n).$$

In the different cases, the quantity  $\Omega$  always corresponds to the linear part of the equation, such that

$$e^{\Omega} = e^{-\alpha x + \beta(\alpha)t}$$

is a solution. Thus  $\beta = \beta(\alpha)$  is essentially the linear dispersion relation (usually written  $\omega = \omega(\alpha)$  with  $\alpha = -ik, \beta = -i\omega$ ). It is surprising that in all cases except the Boussinesq equation (8.9),  $f(\alpha_1, \alpha_2)$  is just

$$(8.89) \quad \frac{1}{\alpha_1 + \alpha_2}$$

146 and even for (8.9) takes the form

$$(8.90) \quad \frac{1}{a_1 + b_2}$$

where  $a_1$  is simply related to  $\alpha_1$  and  $b_2$  is related to  $\alpha_2$ . The pairwise linking in (8.88) classifies a whole group of problems, and for example the matrix form in (8.59) would go through for any  $f$ . It would seem surprising if only such special cases as (8.89) and (8.90) were the only ones of real interest.

A second point in these examples is that the series to be summed is just the expansion of  $(1+P)^{-1}$  or  $(1+P^2)^{-1}$  or some slight variant. Again it would be surprising if these very simple series were the only ones of relevance. But the extent of these methods, as well as the possibility mentioned earlier of summing the crucial part of the series to give a satisfactory approximation, is still not known.

In the direction of classification, the next group would involve factors  $f$  in (8.88) depending on trios of  $\alpha$ 's, but it is not clear that such cases occur or what one could do with them.

# Bibliography

147

- [1] WHITHAM, G.B. (1974), *Linear and nonlinear waves*. Wiley-Interscience, New York.
- [2] TITCHMARSH, E.C. (1962), *Eigenfunction expansions*. Clarendon Press, Oxford.
- [3] TAYLOR, G.I. (1921), Tides in the Bristol channel, *Proc. Camb. Phil. Soc.* 20, 320–325 (also in *The Scientific papers of G.I. Taylor*, Cambridge, 1960, Vol. 2, 185–189).
- [4] CARRIER, G.F., and H.P. GREENSPAN. (1958), Water waves of finite amplitude on a sloping beach, *Jour. Fluid Mech.* 4, 97–109.
- [5] GALVIN, C.J. (1972), Waves breaking in shallow water, *Waves on beaches*, Ed. R.E. Meyer, Academic Press, New York.
- [6] MUNK, W.H. and WIMBUSH, (1969), *Oceanology* 9, 56–59.
- [7] WHITHAM, G.B. (1958), On the propagation of shock waves through regions of non-uniform area or flow, *Jour. Fluid. Mech.* 4, 337–360.
- [8] KELLER, H.B., D.A. LEVINE and G.B. WHITHAM, (1960), Motion of a bore over a sloping beach, *Jour. Fluid. Mech.* 7, 302–316.
- [9] SACHDEV, P.L. and V.S. SESHADRI, (1976), *Jour. Fluid. Mech.* 78, 481–487.

- [10] STOKER, J.J. (1957), *WATER WAVES*, Interscience, New York.
- [11] HANSON, E.T. (1926), The theory of Ship waves. *Proc. Royal Soc. A. 111*, 491–529.
- [12] FRIDRICHS, K.O. (1948) Water waves on a shallow sloping beach. *Comm. Pure and Appl. Math. 1*, 109–134.
- [13] PETERS, A.S. (1952) Water waves over sloping beaches and the solution of a mixed boundary value problem for  $\Delta^2\phi - k^2\phi = 0$  in a sector. *Comm. Pure and Appl. Math. 5*, 87–108.
- 148 [14] URSELL, F. (1952), Edge Waves on a sloping beach. *Proc. Royal Soc. A. 214*, 79–97.
- [15] MINZONI, A.A. (1978), Private communication.
- [16] KORTEWEG, D.J. and G. de VRIES. (1895), On the change of form of long waves advancing in a rectangular canal and on a new type of long stationary waves, *Philosophical Magazine (5) 39*, 422–443.
- [17] GARDNER, C.S., J.M. GREENE., M.D. KRUKSAL., and R.M. MIURA. (1967) Method for solving the Korteweg - de Vries equation. *Physical Review Letters 19*, 1095–1097.
- [18] ROSALES, R.R. (1978), to appear in *Studies in Applied Mathematics*.